

RWC5020x/5021x Tester for LoRaWAN

Operation Manual

Version 1.400
(RWC5020x/5021x FW Version 1.400)

August 2023



Contents

I. General Information	1
1.1 Warranty	1
1.2 Safety Considerations	2
1.2.1 Injury Precautions	2
1.2.2 Product Damage Precautions	3
1.2.3 Safety Symbols and Terms	4
1.2.4 Disposal Requirements under WEEE Regulations	5
1.3 Contact Information	6
1.4 Key Features	6
1.5 Specifications	8
1.6 Initial Inspection	9
1.7 Power Requirement	12
1.8 Operating Environment	12
II. Basic Operation	13
2.1 Front Panel View	14
2.2 Rear Panel View	15
2.3 Common Operation	15
2.3.1 Main Menu Selection	15
2.3.2 Sub Menu Selection	16
2.3.3 Parameter Setup	17
2.3.4 System Setup	18
2.3.5 Rotary Knob	18
2.3.6 Data Input and Modification	18
2.3.7 Edit String	19
2.4 Menu Structure	20
2.5 Display Screen	21
2.5.1 Title Bar	21
2.5.2 Parameter Configuration Screen	21
2.5.3 System Configuration Screen	21
2.5.4 Link Analyzer Screen	21
2.5.5 Power Measure Screen	23
2.5.6 Receiver Sensitivity Screen	0
2.6 Ethernet IP Setup	23
2.7 Firmware Upgrade	23
2.8 Save/Recall	27
III. Functional Operation	31
3.1 Parameter Configuration and Basic Setup for EDT	32
3.1.1 Overview	32
3.1.2 PROTOCOL Parameters	32
3.1.3 RF Parameters	39
3.2 Activation Procedure for EDT	41

3.2.1 Overview	41
3.2.2 OTAA Procedure	41
3.2.3 ABP Procedure	43
3.3 Usage of Link Analyzer for EDT	44
3.3.1 Overview	44
3.3.2 Test Procedure	45
3.3.3 Parameters	46
3.4 Usage of Power Measure for EDT	54
3.4.1 Overview	54
3.4.2 Test Procedure	54
3.4.3 Parameters	55
3.5 Usage of Receiver Sensitivity for EDT	56
3.5.1 Overview	56
3.5.2 Test Procedure	57
3.5.3 Parameters	58
3.6 Transmission of MAC Commands for EDT	61
3.6.1 Overview	61
3.6.2 Test Procedure	61
3.7 Usage of Link Analyzer for Class B EDT	61
3.7.1 Overview	61
3.7.2 Test Procedure	61
3.8 Parameter Configuration and Basic Setup for GWT	62
3.8.1 Overview	62
3.8.2 PROTOCOL Parameters	62
3.8.3 RF Parameters	68
3.9 Activation Procedure for GWT	71
3.9.1 Overview	71
3.9.2 OTAA Procedure	71
3.9.3 ABP Procedure	72
3.10 Usage of Link Analyzer for GWT	72
3.10.1 Overview	72
3.10.2 Test Procedure	72
3.10.3 Parameters	75
3.11 Usage of Power Measure for GWT	79
3.11.1 Overview	79
3.11.2 Test Procedure	79
3.12 Usage of Receiver Sensitivity for GWT	80
3.12.1 Overview	80
3.12.2 Test Procedure	80
3.12.3 Parameters	82
3.13 Transmission of MAC Commands for GWT	82
3.13.1 Overview	82
3.13.2 Test Procedure	82

3.14 Usage of Link Analyzer for Class B GWT	82
3.14.1 Overview	82
3.14.2 Test Procedure	82
3.15 Malfunction Test for EDT / GWT	83
3.15.1 Overview	83
3.15.2 Test Procedure	83
3.16 Usage of Signal Generator for NST	83
3.16.1 Overview	83
3.16.2 Test Procedure	83
3.16.3 NST_TX Parameters	85
3.16.4 RF Parameters	87
3.17 Usage of Signal Analyzer for NST	88
3.17.1 Overview	89
3.17.2 Test Procedure	89
3.17.3 NST_RX Parameters	89
3.17.4 RF Parameters	90
3.18 Usage of MFG for NST	91
3.18.1 Overview	91
3.18.2 Test Procedure	91
3.18.3 NST_MFG Parameters	94
3.18.4 RF Parameters	95
IV. Remote Control Programming	98
4.1 Introduction	98
4.1.1 Command Structure	98
4.1.2 Command Parameter Types	99
4.1.3 Response to Query	100
4.2 RS-232C Interface	100
4.2.1 Configuration	100
4.2.2 Remote Programming Guide Using RS-232C on a Windows System	100
4.3 Ethernet Interface	101
4.3.1 PC Configuration	101
4.3.2 RWC5020A/B Configuration	101
4.3.3 RWC5020M Configuration	101
4.3.4 RWC5021P Configuration	101
4.3.5 UDP Port number	101
4.4 Command List	102
4.4.1 Common Commands	102
4.4.2 Basic Commands	104
4.4.3 Commands for RF Parameters	105
4.4.4 Commands for PROTOCOL Parameters	112
4.4.5 Commands for LINK	117
4.4.6 Commands for POW_MEASURE	127
4.4.7 Commands for SENSITIVITY	131

4.4.8 Commands for NST	132
4.4.9 Commands for SYSTEM	138
V. Revision History	139
Appendix A -	
Basic Operation of RWC5020M	153
A.1 Front Panel View	153
A.2 Rear Panel View	153
A.3 Display Screen	153
A.3.1 IDLE State Screen	154
A.3.2 Running State Screen	154
A.4 IP Type Selection	154
A.5 IP Address Setting	154
A.6 Firmware Upgrade	154
A.7 Other Functions	155
Appendix B -	
Basic Operation of RWC5021P	156
B.1 Front Panel View	157
B.2 Rear Panel View	158
B.3 LED Indicator	159
B.4 IP Type Selection and Address Setting	160
B.4.1 How to change the address and type of IP with a user terminal program	162
B.4.2 How to change the address and type of IP with the RWC5020x/5021x application program	162
B.5 Firmware Upgrade	163
B.6 Other Functions	170

I. General Information

This chapter covers specifications, key features, warranty, and safety consideration of the Instrument.

- 1.1 Warranty
- 1.2 Safety Considerations
- 1.3 Contact Information
- 1.4 Key Features
- 1.5 Specifications
- 1.6 Initial Inspection
- 1.7 Power Requirement
- 1.8 Operating Environment

1.1 Warranty

RedwoodComm Warrants that this product will be free from defects in materials and workmanship for a period of two(2) years from the date of shipment. During the warranty period, RedwoodComm Company will, at its option, either repair or replace products that prove to be defective.

For warranty service or repair, Customer must notify RedwoodComm of the defect before the expiration of the warranty period and make suitable arrangements for the performance of service. Customer shall be responsible for packaging and shipping the defective product to the service center designated by RedwoodComm. Customer shall prepay shipping charge to RedwoodComm designated service center and RedwoodComm shall pay shipping charge to return the product to customer. Customer is responsible for all shipping charges including freight, taxes, and any other charge if the product is returned for service to RedwoodComm, if customer is located outside of Korea.

LIMITATION OF WARRANTY

The foregoing warranty shall not apply to defects resulting from improper or inadequate malignance by buyer, buyer-supplied software or interfacing, unauthorized modification or misuse, accident or abnormal conditions of operation.

RedwoodComm responsibility to repair or replace deductive products is the sole and exclusive remedy provided to the customer for breach of this warranty. RedwoodComm will not be liable for any indirect, special, incidental, or consequential damages irrespective of whether RedwoodComm has advance notice of the possibility of such damages

1.2 Safety Considerations

Review the following safety precautions to avoid injury and prevent damage to this product or any product connected to it.

1.2.1 Injury Precautions

Use Proper Power Cord

To avoid fire hazard, use only the power cord specified for this product.

Avoid Electric Overload

To avoid electric shock or fire hazard, do not apply a voltage to a terminal that is specified beyond the range.

Ground the Product

This product is grounded through the grounding conductor of the power cord. In case no ground is available at the power outlet, it is recommended to provide a separate grounding path to the instrument by connecting wire between the instrument ground terminal and an earth ground to avoid electric shock or instrument damage. Before making connections to the input or output terminals of the product, ensure that the product is properly grounded.

Do Not Operate Without Covers

To avoid electric shock or product damage, do not operate this product with protective covers removed.

Do Not Operate in Wet/Damp Conditions

To avoid injury or fire hazard, do not operate this product in wet or damp conditions.

Do not use in a manner not specified by the manufacturer

1.2.2 Product Damage Precautions

Use Proper Power Source

Do not operate this product from a power source that applies more than the voltage specified. Main supply voltage fluctuations do not exceed $\pm 10\%$ of the nominal voltage.

Provided Proper Ventilation

To prevent product overheating, provide proper ventilation.

Do Not Operate With Suspected Failures

If there is damage to this product, have it inspected by qualified service personnel.

Environmental Conditions

Refrain from using this equipment in a place subject to much vibration, direct sunlight, outdoor and where the flat is not level. Also, do not use it where the ambient temperature is outside 5 °C to 40 °C, and altitude is more than 2000m. The maximum relative humidity is 80% for temperatures up to 31 °C decreasing linearity to 50% relative humidity at 40 °C. Over voltage Installation Category II for mains supply. Pollution Degree 2.

1.2.3 Safety Symbols and Terms

These terms may appear in this manual

WARNING: Warning statements identify conditions or practices that could result in injury or loss of life.

CAUTION: Caution statements identify conditions or practices that could result in damage to this product or other property.

Symbols on the Product: The following symbols may appear on the product



Close



Open



ATTENTION



Indicates earth
(ground) terminal

1.2.4 Disposal Requirements under WEEE Regulations

For private households: Information on Disposal for Users of WEEE

The following symbol on the product(s) and / or accompanying documents means that used electrical and electronic equipment (WEEE) should not be mixed with general household waste. For proper treatment, recovery and recycling, please take this product(s) to designated collection points where it will be accepted free of charge. Alternatively, in some countries, you may be able to return your products to your local retailer upon purchase of an equivalent new product.



Disposing of this product correctly will help save valuable resources and prevent any potential negative effects on human health and the environment, which could otherwise arise from inappropriate waste handling.

Please contact your local authority for further details of your nearest designated collection point.

Penalties may be applicable for incorrect disposal of this waste, in accordance with your national legislation.

For professional users in the European Union

If you wish to discard electrical and electronic equipment (EEE), please contact your dealer or supplier for further information.

For disposal in countries outside of the European Union

This symbol is only valid in the European Union (EU). If you wish to discard this product please contact your local authorities or dealer and ask for the correct method of disposal.

1.3 Contact Information

The contact information of RedwoodComm Headquarters is as follows:

Telephone: +82-70-7727-7011

Technical Support: support@redwoodcomm.com

Homepage: <http://www.redwoodcomm.com>

1.4 Key Features

General Descriptions

RWC5020A/B/M is a compact all-in-one tester, providing a perfect solution for test and measurement of LoRaWAN technology, which is fully suitable for R&D, QC, and Manufacturers. It provides various test functions that can be performed in signaling mode, e.g. including activation procedures, as well as non-signaling mode. The automated PC application software will help users test and debug their devices by performing the pre-certification tests, as specified by the LoRa Alliance.

Key Features

3 Operational Modes

- End Device Test
 - Testing an End Device by operating as a Gateway
- Gateway Test
 - Testing a Gateway by operating as an End Device
- Non-signaling Test
 - Generating LoRa frames or continuous waveform

Protocol Functional Tests

- LoRaWAN® Compatibility
 - Supporting Class A/B/C for V1.0.2, V1.0.3, V1.0.4 and V1.1
 - Supported Regions: EU 868, EU 433, US 915, AU 915, CN 470, KR 920, AS 923, IN 865, and RU 864
- Link Analyzer
 - Analysis of Protocol messages and parameters
 - Transmission of any type of MAC commands
- Pre-Certification Tests (End Device only)
 - LoRaWAN® Certification for V1.0.2: EU V1.6, US V1.5.1, AS V1.1.1, KR V1.2.1, IN1.1.1
 - LoRaWAN® Certification for V1.0.4: All Regions V1.6
 - LoRaWAN® Class B Certification for V1.0.4: All Regions V1.0
 - LoRaWAN® Class C Certification for V1.0.4: All Regions V1.0.1
 - * Supporting up to eight 125kHz CHs and one 500kHz CH simultaneously
 - Operator Certification

RF Performance Tests

- End Device Test
 - Receiver Sensitivity Test w.r.t. DR (DR0 ~ DR7) or Downlink Slot (RX1 and RX2 Window)
 - TX Power Measurement w.r.t. DR (DR0 ~ DR7) or RF channel (up to 8 channels)
 - TX Frequency Measurement using ENABLE_CW_MODE MAC command
- Gateway Test
 - Receiver Sensitivity Test w.r.t. DR (DR0 ~ DR7)
 - TX Power Measurement w.r.t. DR (DR0 ~ DR7) or RF channel (up to 8+1 channels)
- Manufacturing Tests
 - RX Test: Receiver Sensitivity Test with known test pattern of LoRa frames
 - TX Test: Power Measurement
 - MFG Test: Combine TX/RX Test with special test procedure defined by RedwoodComm

PC Software

- LoRaWAN Pre-certification Tests (EDT)
- Non-Regression Tests (GWT)
- RF Performance Tests (EDT, GWT)
- Listen Before Talk (LBT) Test (EDT, GWT)
- Link Analyzer / MAC Command Scriptor (EDT, GWT)
- Application Layer Tests
 - FUOTA (Firmware Update Over The Air) Test function (EDT)

1.5 Specifications

Frequency

- Range: 400MHz ~ 510MHz, 862MHz ~ 960MHz
- Resolution: 100Hz
- Stability vs. +25°C: ± 0.5 ppm standard
- Stability vs. Aging: ± 1 ppm/1st year

Output Level

- Range: -10dBm ~ -150dBm for RWC5020A,
0dBm ~ -150dBm for RWC5020B/M,
0dBm ~ -30dBm for RWC5021P
- Resolution: 0.5dB for RWC5020A,
0.1dB for RWC5020B/M,
0.5dB for RWC5021P
- Accuracy: ± 1 dB for RWC5020A/B/M,
 ± 2 dB for RWC5021P
- Impedance: 50 Ω

Input Level

- Range for Power measurement:
+30dBm ~ -40dBm for RWC5020A,
+30dBm ~ -80dBm for RWC5020B/M,
+30dBm ~ -80dBm for RWC5021P
- Range for Frequency measurement:
+30dBm ~ -50dBm for RWC5020B/M
- Accuracy for Power measurement:
 ± 1 dB for Power for RWC5020A/B/M,
 ± 2 dB for Power for RWC5021P
- Accuracy for Frequency (Single Tone) measurement:
 ± 1 KHz for RWC5020B/M

VSWR

- Better than 1:1.5

External Frequency Reference (RWC2020A/B/M)

- Frequency: 10MHz
- Power Range: 0dBm ~ +20dBm MAX

Remote Programming Ports

- RJ45 (Ethernet)
- RS-232C

Miscellaneous (RWC5020A/B)

- Operating temperature: 5 ~ 40°C
- Line Voltage: 100 to 240 VAC, 50/60Hz
- Dimension: 250(w) x 110(h) x 348(d) mm
- Weight: 5kg

Miscellaneous (RWC5020M)

- Operating temperature: 5 ~ 40°C
- Power Input: DC 12V/3A
- Dimension: 200(w) x 70(h) x 220(d) mm
- Weight: 2.2kg

Miscellaneous (RWC5021P)

- Operating temperature: 5 ~ 40°C
- Power Input: DC 5V/0.5A
- Dimension: 100(w) x 30(h) x 140(d) mm
- Weight: 0.5kg

1.6 Initial Inspection

After the delivery of the product, damage to its exterior that may occur during the shipping process should be inspected, then it should be carefully checked that all accessories are included as listed in the following table:

Table for RWC5020A/B

NO.	Item Code	Item	Specifications	Q'ty
1	C5020X-XX	RWC5020A/B Tester for LoRaWAN		1
2	5020A00-8001	PC program & Manual (USB Memory)		1
3	6000-0001-001	RG58, BNC(M) to BNC(M)	L:1m	1
4	6016-0001-001	MF405, SMA(M) to SMA(M) Cable	L:0.5m	1
5	6211-0002-001	SMA(F) to N(M) Adaptor		1
6	6210-0003-001	SMA(F) to RP-SMA(M) Adapter		1
7	6500-0001-001	Linear Antenna, 863~928MHz		1
8	6112-0001-001	RJ45 Cross LAN Cable	2m	1
9	6115-0001-001	RS-232C, Data Cable	1.8m	1
10	6114-00XX-001	Power Cord		1

Table for RWC5020M

NO.	Item Code	Item	Specifications	Q'ty
1	C5020M-00	RWC5020M Tester for LoRaWAN		1
2	5020A00-8001	PC program & Manual (USB Memory)		1
3	6000-0001-001	RG58, BNC(M) to BNC(M)	L:1m	1
4	6016-0001-001	MF405, SMA(M) to SMA(M) Cable	L:0.5m	1
5	6211-0002-001	SMA(F) to N(M) Adaptor		1
6	6210-0003-001	SMA(F) to RP-SMA(M) Adapter		1
7	6500-0001-001	Linear Antenna, 863~928MHz		1
8	6112-0001-001	RJ45 Cross LAN Cable	2m	1
9	6115-0001-001	RS-232C, Data Cable	1.8m	1
10	4150-0002-001	SMPS Adaptor, DC 12V 3A		1
11	6114-00XX-001	Power Cord		1

Table for RWC5021P

NO.	Item Code	Item	Specifications	Q'ty
1	C5021P-00	RWC5021P Long Range WAN Protocol Tester		1
2	5020A00-8001	PC program & Manual (USB Memory)		1
3	6016-0001-001	MF405, SMA(M) to SMA(M) Cable	L:0.5m	1
4	6112-0001-001	RJ45 Cross LAN Cable	2m	1
5	6113-0001-001	USB C-Type Cable	1m	1

WARNING: If any damage to the interior or exterior of the product is found, please stop using immediately for safety and contact the technical support.

1.7 Power Requirement

RWC5020A/B, RWC5020M, and RWC5021P have different power inputs. See the detailed specifications below.

Items	Specifications for RWC5020A/B
Input Voltage	100 VAC - 240 VAC
Input Current	1.2A
Frequency	50/60 Hz
Power Consumption	< 40 watt

Items	Specifications for RWC5020M
Input Voltage	DC 12V
Input Current	3A
Power Consumption	< 36 watt

Items	Specifications for RWC5021P
Input Voltage	DC 5V (USB-C type)
Input Current	0.5A
Power Consumption	< 2.5 watt

CAUTION: If AC power is beyond the range of operation, the equipment may malfunction or could be permanently damaged. Main supply voltage fluctuations should be not to exceed $\pm 10\%$ of the nominal voltage.

1.8 Operating Environment

Refrain from using this equipment in a place subject to much vibration, direct sunlight, outdoor and where the flat is not level. Also, do not use it where the ambient temperature is outside 5 °C to 40 °C, and altitude is more than 2000m.

The maximum relative humidity is 80% for temperatures up to 31 °C decreasing linearity to 50% relative humidity at 40 °C. Over voltage Installation Category II for main supply. Pollution Degree 2.

The storage temperature range for this equipment is –20 °C to 70 °C. When this equipment is not used for a long period of time, store it in a dry place away from direct sunlight, covered with vinyl or placed in a cardboard box.

II. Basic Operation

This section describes the basic concepts and details of operating RWC5020A/B Tester for LoRaWAN. Understanding the basic concept of your RWC5020A/B may help you use it effectively. For RWC5020M and RWC5021P, please refer to the Appendix A and B respectively.

- 2.1 Front Panel View
- 2.2 Rear Panel View
- 2.3 Common Operation
- 2.4 Menu Structure
- 2.5 Display Screen
- 2.6 Ethernet IP Setup
- 2.7 Firmware Upgrade
- 2.8 Save/Recall

2.1 Front Panel View

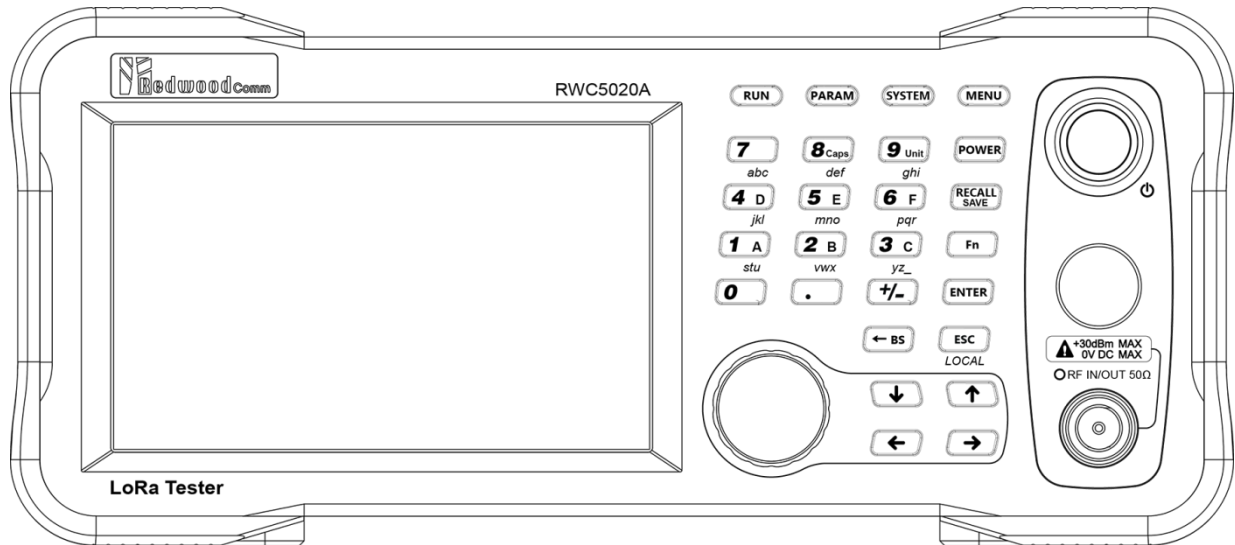





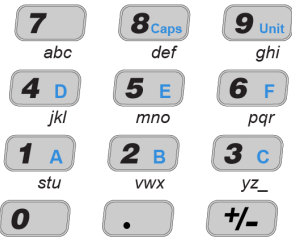







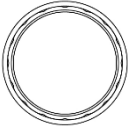



Fig 2.1 RWC5020A/B Front Panel View

NO	Items	Names and Descriptions
1		5-inch LCD Display
2		Main Menu selection key
3		System Setup key
4		Parameter Setup key
5		RUN / STOP key
6		Number and letter input keys, Float point input key, Minus sign input key
7		Shortcut key for output power setting

8		Shortcut key for recall or save of system and parameter setup
9		Functional key for a secondary key input
10		Data input completion, Input mode switching
11		Input cancel, Popup window release, Return to the previous state, LOCAL mode switching (LOCAL)
12		Key to delete the previous character
13		Cursor move, tab switching, Cursor mode switching
14		Rotary Knob: Cursor move, value changing Push: same as “ENTER”
15		RF IN/OUT Connectors
16		Power Switch

2.2 Rear Panel View

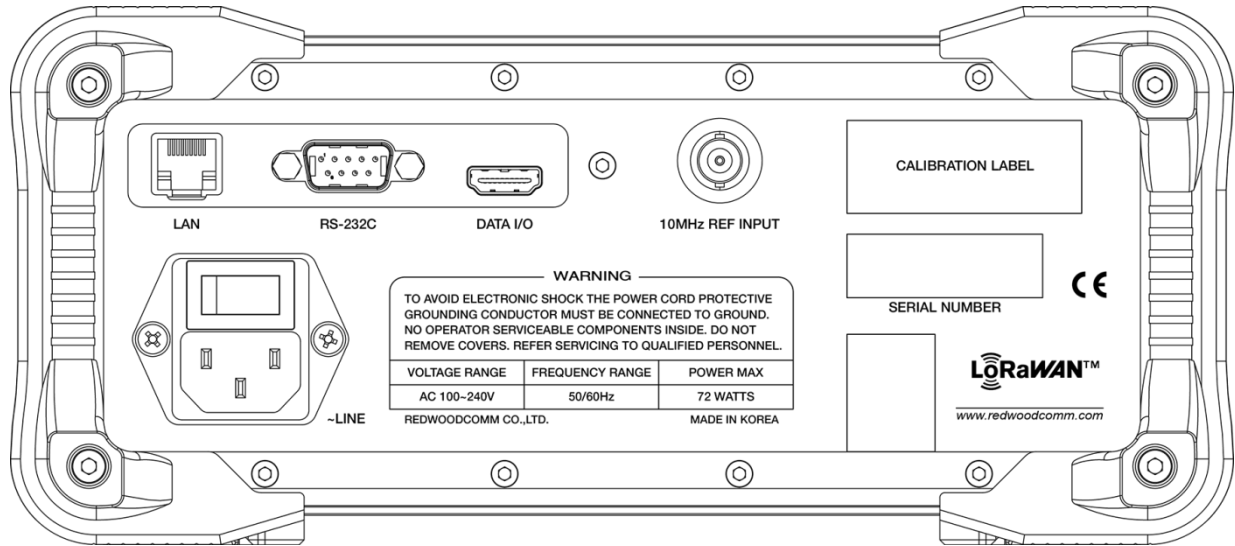



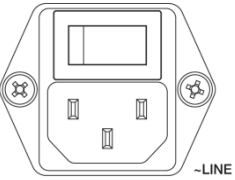

Fig 2.2 RWC5020A/B Rear Panel View

NO	Items	Names and Descriptions
1	 LAN	Ethernet Interface
2	 RS-232C	RS-232C Interface
3	 DATA I/O	Sync Data I/O between RedwoodComm instruments
4	 10MHz REF INPUT	10MHz External Reference Signal input
5	 -LINE	100~240VAC Power Input

2.3 Common Operation

2.3.1 Main Menu Selection

RWC5020A/B Tester for LoRaWAN has a tree type menu structure and 3 Main Menus. Pressing **MENU** key pops up the Main Menu selection screen and each Main Menu can be selected by pressing a direct number key (1, 2, or 3) or rotating the rotary knob and pressing **ENTER** key. The following figure shows the Main Menu selection screen.

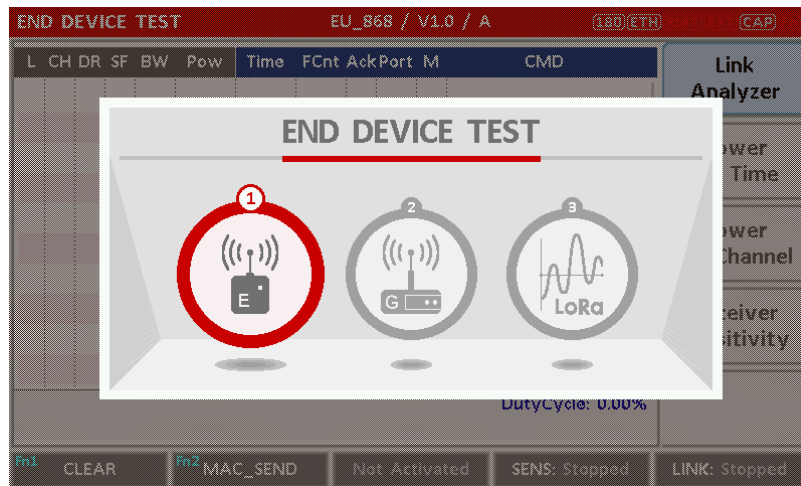

Fig 2.3 Main Menu Selection Screen

Main Menu	Descriptions
END DEVICE TEST	This is a menu for testing End Device; RWC5020A/B acts as the reference Gateway/ Server to communicate with End Device Under Test, while analyzing protocol messages and measuring the signal quality and performance of DUT.
GATEWAY TEST	This is a menu for testing Gateway; RWC5020A/B acts as the reference End Device to communicate with Gateway Under Test, while analyzing protocol messages and measuring the signal quality and performance of DUT.
NON-SIGNALING TEST	This is a menu for generating a continuous waveform signal or a LoRa test frame and measuring the power of DUT signal.

2.3.2 Sub Menu Selection

Each main menu has its own Sub Menu as displayed on the right side of the screen. Each Sub Menu can be selected by rotating the rotary knob and pressing **ENTER** key or touched screen the area of Sub Menu. The following figure shows the example of the Sub Menu selection. In Power Measure Sub Menu, there

are two modes (Power vs. Time and Power vs. Channel) and it is toggled by selecting Power Measure Sub Menu again.

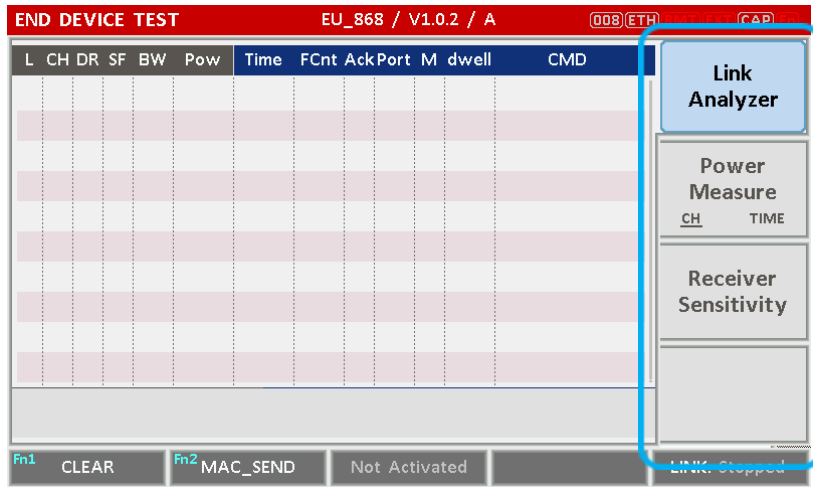

Fig 2.4 Sub-Menu Selection Screen (blue colored box)

2.3.3 Parameter Setup

Pressing **PARAM** key pops up the parameter configuration screen, and it has 3 different tabs. The first tab is a parameter set of the current Sub Menu, and the second and the third tabs are common sets of protocol and RF parameters respectively. The following figure shows the example of the parameter configuration screen.



Fig 2.5 Parameter Configuration Screen

2.3.4 System Setup

Pressing **SYSTEM** key pops up the system configuration screen. The SETUP tab is a parameter set of the

system configuration. The following figure shows the system configuration screen.



Fig 2.6 System Configuration Screen

2.3.5 Rotary Knob

The rotary knob moves the cursor to every field on the screen that can be changed. By positioning the cursor in front of a field and pressing the knob to select that field, you can alter that field's setting.

2.3.6 Data Input and Modification

1. Move the cursor to the desired input field using rotary knob or arrow keys.
2. Push rotary knob or **ENTER** key for data input mode. The cursor indicates data input position. If there are only two alternatives, push the rotary knob or **ENTER** key to toggle the data. In case of pop-up menu rotate the rotary knob to choose.
3. Push Rotary knob to enter data and then the new data is entered.
4. While entering the data, if you press **ESC** or **← BS** key, the input data shall be cancelled or deleted respectively.

2.3.7 Edit String

1. To edit the string, move cursor to the Label parameter and set it to input mode by pushing the rotary knob or **ENTER** key then input cursor will be placed at the last of string. Press the number keys repeatedly, then the numbers and characters are displayed repeatedly.
2. When the desired number or character is displayed, please wait until the cursor is moved to the next position.

2.4 Menu Structure

RWC5020A/B has a tree type menu structure as the following figure. There are 3 Main Menus and each Main Menu has 2 - 4 Sub Menus.

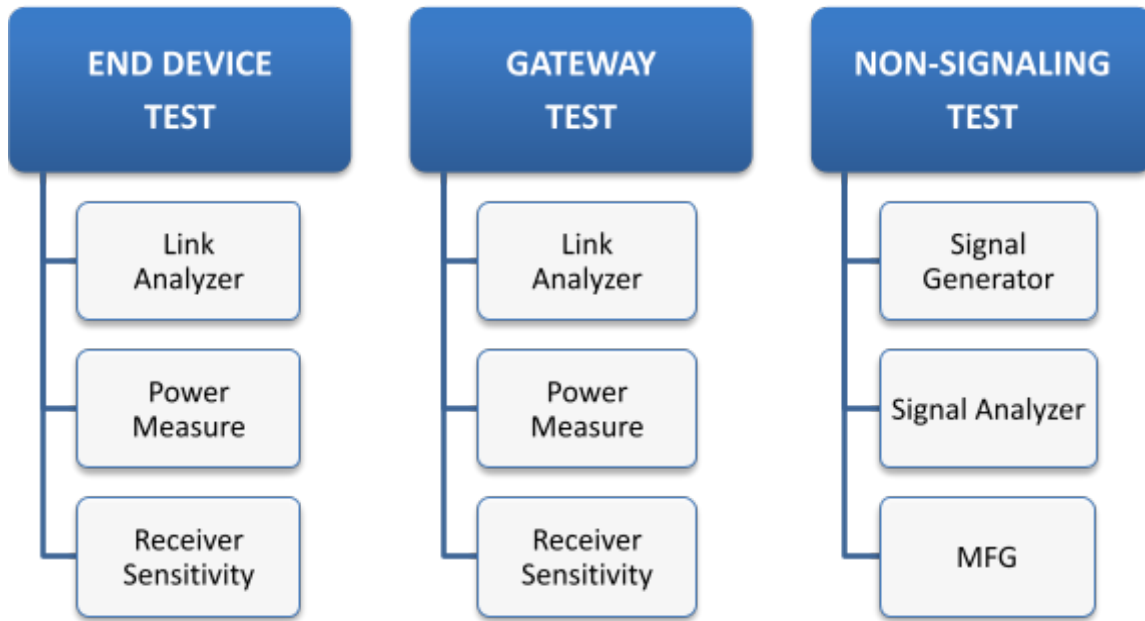

Fig 2.7 RWC5020A/B Menu Structure

2.5 Display Screen

2.5.1 Title Bar

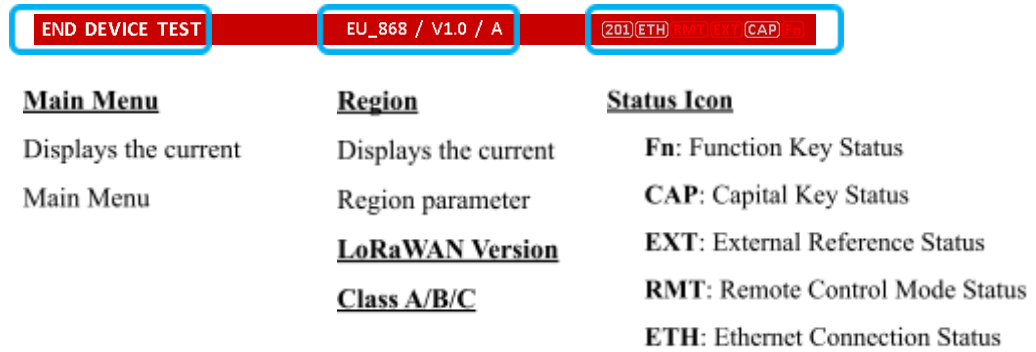

Fig 2.8 Title Bar

2.5.2 Parameter Configuration Screen

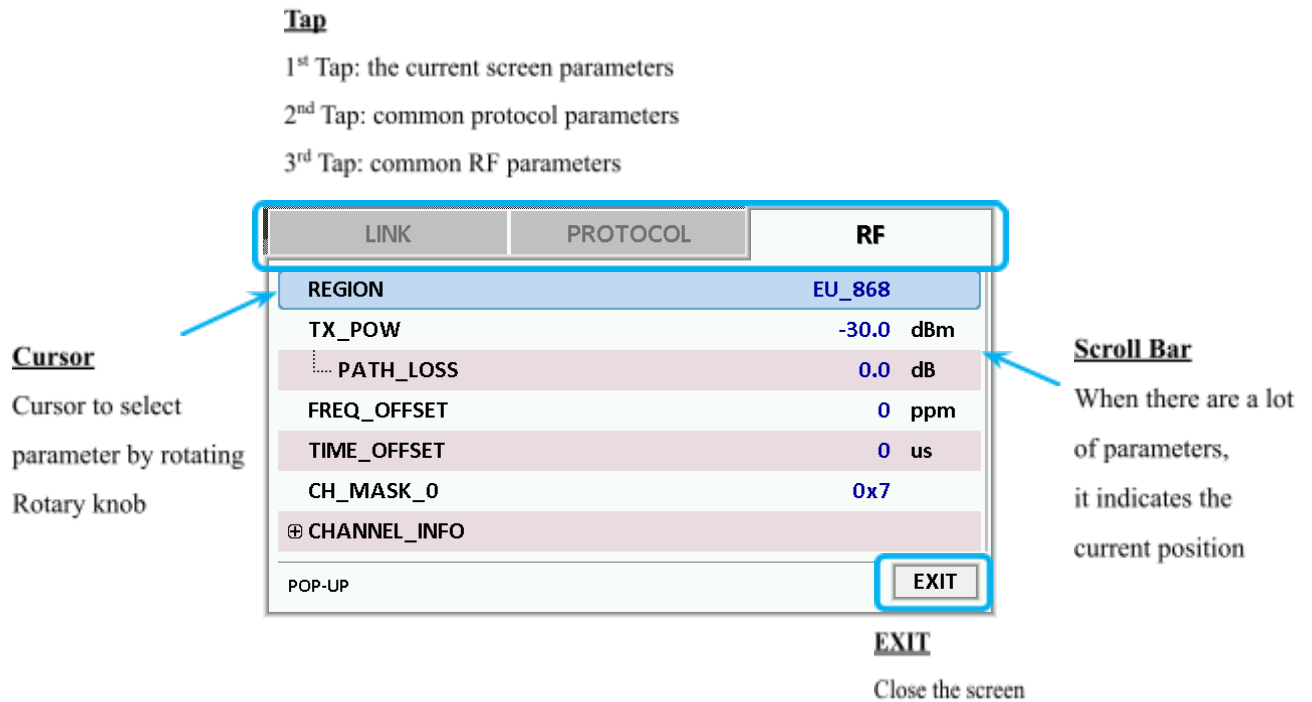

Fig 2.9 Parameter Configuration Screen

2.5.3 System Configuration Screen

Tap

1st Tap: the system parameters and information

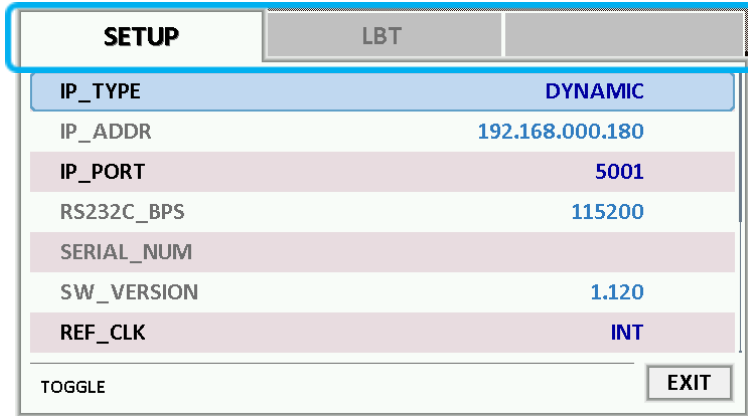

Fig 2.10 System Configuration Screen

2.5.4 Link Analyzer Screen

LINK Message Window

L: Uplink/Downlink Time: Time between consecutive frames
 CH: Channel Number FCnt: FCnt value Del: RxDelay value
 DR: Data Rate Adr: ADR flag Ack: ACK flag
 SF: Spreading Factor B: Class B flag Port: FPort value
 BW: Bandwidth M: Type (Confirmed/Unconfirmed)
 Pow: Measured power FP: FPending flag AAR: ADRAckReq flag
 CMD: Command Name

Cursor

Cursor to select message by rotating Rotary knob

Contents

Information of Command

Raw Data

Raw data of the current cursor position

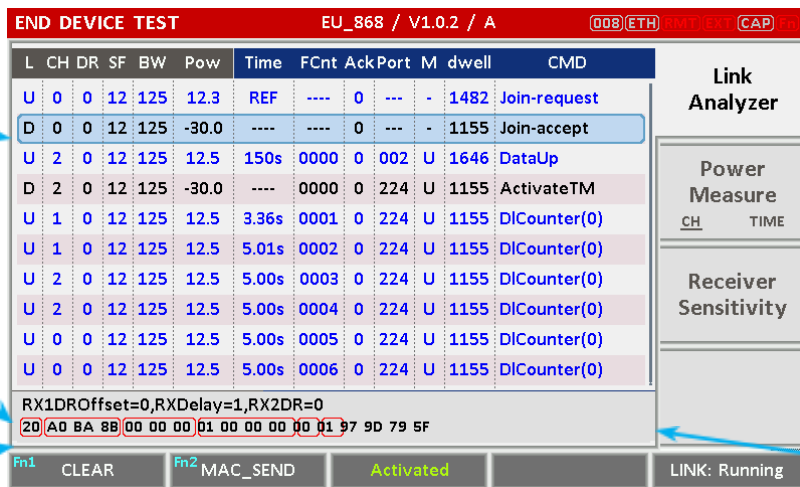

Duty Cycle

Calculated duty cycle value of DUT transmission

Fig 2.11 Link Analyzer Screen

CLEAR

Pushing 'CLEAR' or pressing **Fn 1 A** will clear all messages on the Link Analyzer screen and also clear all measured power data in Power vs. Time and Power vs. Channel screens.

MAC SEND

Pushing 'MAC_SEND' or pressing **Fn 2 B** will force RWC5020A/B to send the selected MAC command to DUT at its next TX period, where the MAC command can be selected in the parameter configuration screen.

LINK

It represents the status of communication link between DUT and RWC5020A/B; Running or Stopped.

Pushing **RUN** key changes the link status in Link Analyzer, Power vs. Time or Power vs. Channel screen.

SENS

It represents the status of the Receiver Sensitivity test of DUT; Running or Stopped. Pushing **RUN** key changes the sensitivity status in Receiver Sensitivity screen.

2.5.5 Power Measure Screen

Power vs. Time Mode

Marker Values

The corresponding values at the current marker position

Marker

marker to select a point by rotating Rotary knob

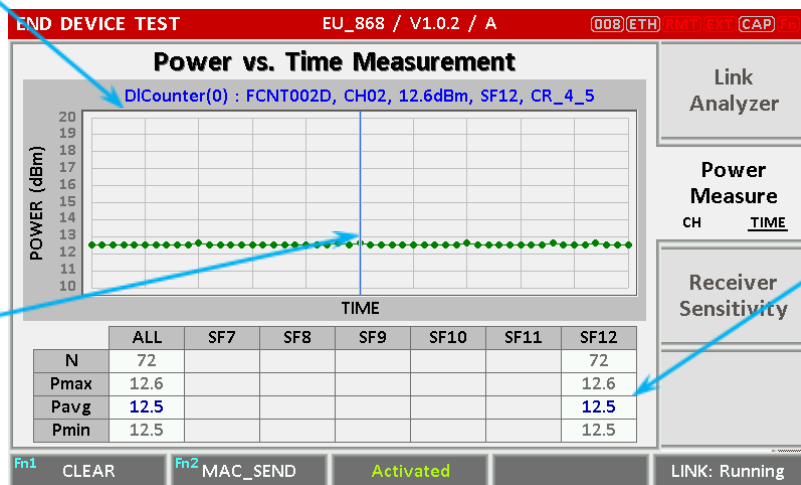

Measured Power

The measured power values with respect to data rates

Fig 2.12 Power vs. Time Screen

2.5.6 Receiver Sensitivity Screen

Test Results

The final test results will be displayed after the completion of the test

Sensitivity Graph

It draws PER graph at each test point

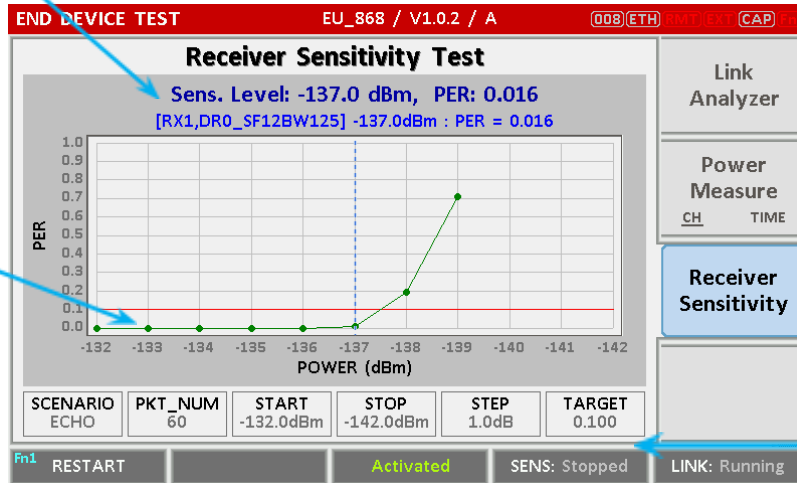

Test Setup

The important test parameters are displayed

Fig 2.14 Receiver Sensitivity Screen

2.6 Ethernet IP Setup

IP configuration can be done by “IP_TYPE” and “IP_ADDR” in the system configuration screen.

“IP_TYPE” parameter can be set to DYNAMIC or STATIC; DYNAMIC means that IP address may be obtained from the DHCP server automatically, and this configuration is recommended for RJ45 connection to a network hub. STATIC means that IP address should be configured manually by users, and this configuration is recommended for direct connection between RWC5020A/B and a remote PC using a crossover cable.

SETUP	LBT
IP_TYPE	STATIC
IP_ADDR	192.168.000.101
IP_PORT	5001
RS232C_BPS	115200
SERIAL_NUM	
SW_VERSION	1.120
REF_CLK	INT
TOGGLE	EXIT

Fig 2.15 Example of STATIC IP

SETUP	LBT
IP_TYPE	DYNAMIC
IP_ADDR	192.168.000.180
IP_PORT	5001
RS232C_BPS	115200
SERIAL_NUM	
SW_VERSION	1.120
REF_CLK	INT
TOGGLE	EXIT

Fig 2.16 Example of DYNAMIC IP

2.7 Firmware Upgrade

As RWC5020A/B adapted Flash Memory, it is available to upgrade easily by using a remote PC without changing the hardware. For upgrading, 'RWC_Updater' program shall be used, which is provided together when the product is purchased or available to download the upgrade package including itself and the upgrade binary files from RedwoodComm Website (<http://www.redwoodcomm.com>). The information for upgrading shall be kept in providing to the user via email or website. For firmware upgrades of RWC5020M and RWC5021P, please refer to the Appendix.

Normal Firmware Upgrade Procedure

- 1) Set up Ethernet connection between RWC5020A/B and a remote PC, using a RJ45 cable for normal connection to network hub or using a crossover cable for direct connection between them.
- 2) In case of direct connection using a crossover cable, IP configuration of a remote PC should be done manually as the following figure. The IP address of a remote PC shall be the same as that of RWC5020A/B except the last number.

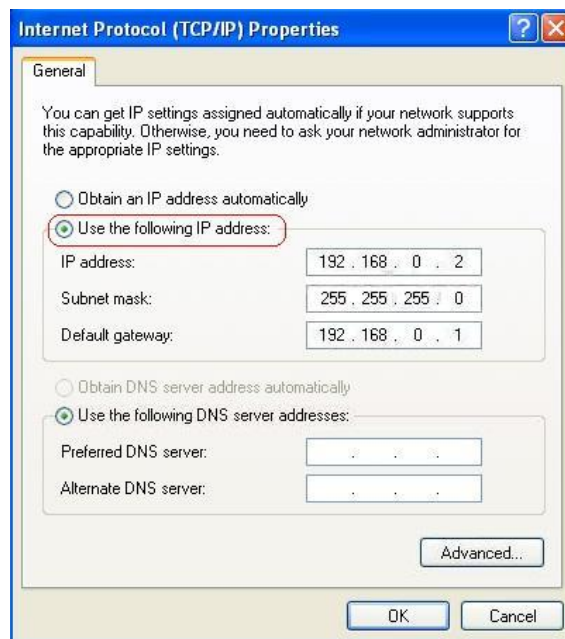

Fig 2.17 IP configuration of a remote PC

CAUTION: For reliable upgrade, it is recommended to disable all other networks (e.g. WiFi, Virtual Machine) than Ethernet network in 'Change Adapter Settings' of a remote PC.

- 3) After downloading upgrade files from RedwoodComm website, execute an application program for upgrading.
- 4) Set up the IP address in the application program, and follow the instructions of the program.
- 5) During upgrading, RWC5020A/B may show the progressing information on its screen as the following figure.

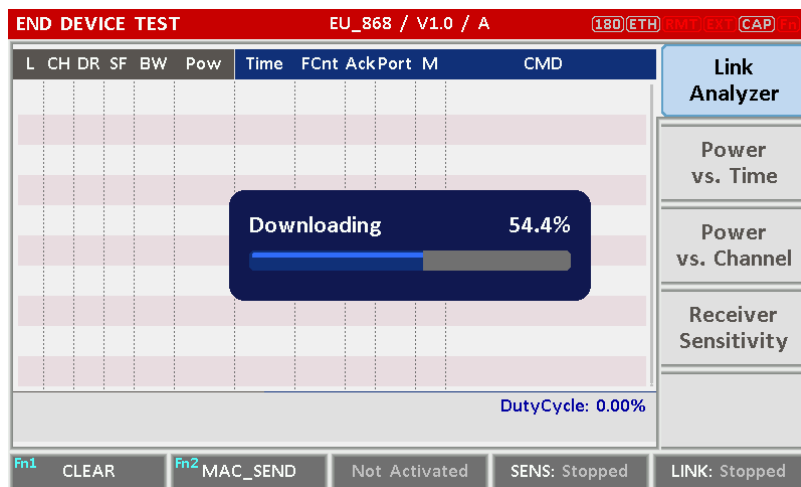

Fig 2.18 Firmware Upgrade Screen

- 6) After upgrading completed, reboot RWC5020A/B and check the software version in the system configuration screen.

CAUTION: If upgrading fails, turn on RWC5020A/B in Emergency Upgrade Mode and upgrade firmware again. Refer to “Emergency Firmware Upgrade Procedure”.

Emergency Firmware Upgrade Procedure

- 1) If Normal Firmware Upgrade Procedure fails during upgrading, the internal memory may be damaged. In this case, RWC5020A/B may not boot correctly. Then RWC5020A/B must be upgraded in Emergency Upgrade Mode.

- 2) Turn off RWC5020A/B. While keeping **RUN** key pressed, turn on RWC5020A/B. Then RWC5020A/B will boot in Emergency Upgrade Mode as the following figure.
- 3) Make a direct connection between a remote PC and RWC5020A/B using a crossover cable and wait until the IP address of RWC5020A/B will be displayed on the screen.
- 4) Follow the steps 3) to 6) of Normal Firmware Upgrade Procedure.



Fig 2.19 RWC5020A/B Boot Screen of Emergency Upgrade Mode

2.8 Save/Recall

The SAVE and RECALL functions allow you to store different instrument setups and retrieve them later. By saving test setups, you can save time by eliminating the task of re-configuring the instrument. The instrument supports up to 10 save/recall sets.

2.8.1 Save Method

Make any changes to the instrument that you want to SAVE in a memory. Then press **Fn** + **RECALL SAVE** key to execute SAVE pop-up screen as the following figure. Select SAVE buffer number and press **ENTER** key.



Fig 2.20 Screen of Parameter Configuration SAVE

2.8.2 Recall Method

Then press **RECALL SAVE** key to execute RECALL pop-up screen as following figure. Select RECALL buffer number and press **ENTER** key. The first RECALL buffer is RESET. If you select it, the instrument will be reset, i.e., factory reset.



Fig 2.21 Screen of Parameter Configuration RECALL

2.8.3 Selection of Boot Configuration

When restarting the system, one of the saved configurations will be retrieved. To define saved configuration for booting, press **(SYSTEM)** key and modify BOOT_BY to desired RECALL buffer number on the system configuration screen.

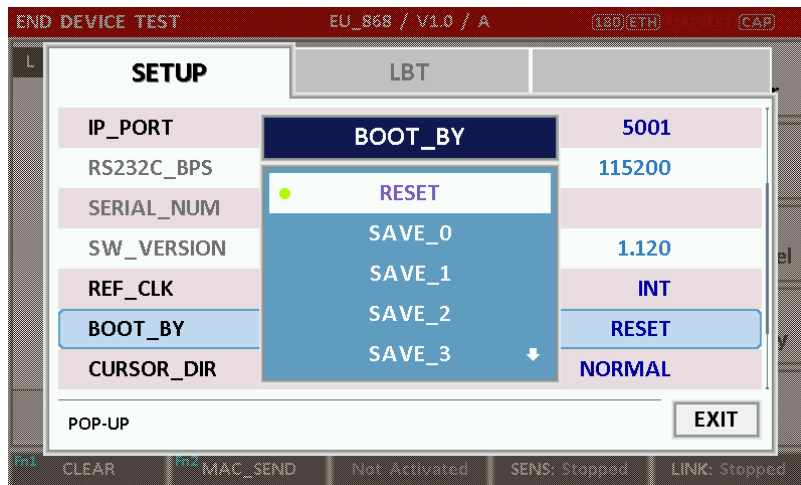

Fig 2.22 Screen of Configuration Setup for Boot

III. Functional Operation

This section describes the basic concepts and details of operating RWC5020A/B Tester for LoRaWAN. Understanding the basic concept of your RWC5020A/B may help you use it effectively. For RWC5020M and RWC5021P, please refer to the Appendix A and B respectively.

- 3.1 Parameter Configuration and Basic Setup for EDT
- 3.2 Activation Procedure for EDT
- 3.3 Usage of Link Analyzer for EDT
- 3.4 Usage of Power Measure for EDT
- 3.5 Usage of Receiver Sensitivity for EDT
- 3.6 Transmission of MAC Commands for EDT
- 3.7 Usage of Link Analyzer for Class B EDT
- 3.8 Parameter Configuration and Basic Setup for GWT
- 3.9 Activation Procedure for GWT
- 3.10 Usage of Link Analyzer for GWT
- 3.11 Usage of Power Measure for GWT
- 3.12 Usage of Receiver Sensitivity for GWT
- 3.13 Transmission of MAC Commands for GWT
- 3.14 Usage of Link Analyzer for Class B GWT
- 3.15 Malfunction Test for EDT / GWT
- 3.16 Usage of Signal Generator for NST
- 3.17 Usage of Signal Analyzer for NST
- 3.18 Usage of MFG for NST

3.1 Parameter Configuration and Basic Setup for EDT

3.1.1 Overview

To create a link with an End Device and measure its performances, various protocol parameters as well as RF parameters should be configured in advance for users' purposes. This configuration is done in the parameter configuration screen as the following figure. Refer to 3.1.2 and 3.1.3 for descriptions of parameters.

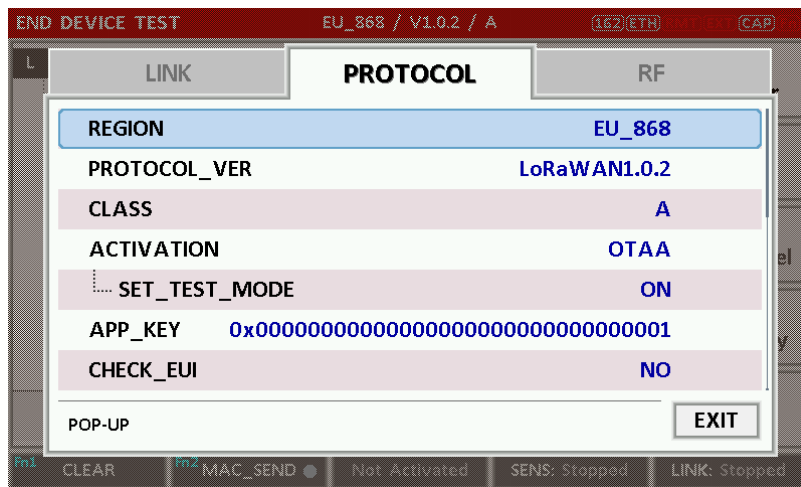

Fig 3.1 EDT Parameter Configuration Screen - PROTOCOL



Fig 3.2 EDT Parameter Configuration Screen - RF

3.1.2 PROTOCOL Parameters

REGION

RWC5020A/B supports various regions [EU 868, EU 433, US 915, AU 915, CN 470, KR 920, AS 923, IN 865, RU 864]. Using this parameter, the user could select the region to test.

OPERATOR

This parameter determines whether to enable LoRa operator-specific procedures and parameters. It is only applicable to South Korea (SKT) and China (ICA) in the current version of firmware.

PROTOCOL_VER

This parameter defines the version of LoRaWAN protocol to be emulated by RWC5020A/B.

CLASS

There are three different classes in LoRa devices. Class A is Bi-directional End Devices, Class B is Bi-directional End Devices with scheduled receive slots, and Class C is Bi-directional End Devices with maximal receive slots. This parameter defines the class mode of RWC5020A/B.

ACTIVATION

LoRaWAN defines two types of Activation procedures (OTAA, ABP). This parameter defines the activation mode of RWC5020A/B.

SET_TEST_MODE

This parameter determines whether to force DUT to enter certification test mode by sending the *Activated Test Mode* command after the activation procedure. For LoRaWAN1.0.4 and LoRaWAN1.1, the TxPerChangeReq MAC command is used instead of the *Activated Test Mode* command.

APP_KEY

The APP_KEY is an AES-128 root key specific to the End Device. Whenever an End Device joins a network via over-the-air activation, the APP_KEY is used to derive the session keys NwkSKey and AppSKey specific for that End Device to encrypt and verify network communication and application data. This parameter must be set to the same value as the APP_KEY on DUT.

CHECK_EUI

This parameter decides whether or not to compare DEV_EUI and APP_EUI during activation. If this

parameter is ON, RWC5020A/B (Gateway/Server) compares DEV_EUI and APP_EUI and accepts only if the value is equal to the same.

DEV_EUI

The DEV_EUI is a globally unique End Device identifier. The DEV_EUI is stored in the End Device before the activation procedure is executed. If the CHECK_EUI is ON, this parameter must be set as the same value stored on the DUT.

APP_EUI

The APP_EUI is a global application ID in IEEE EUI64 address space that uniquely identifies the entity able to process the Join-request frame. The APP_EUI is stored in the End Device before the activation procedure is executed. If the CHECK_EUI is ON, this parameter must be set as the same value stored on the DUT.

DEV_ADDR

During the activation, the gateway assigns DEV_ADDR value to the End Device. If activation mode is ABP, this parameter must be set as the same value stored on the DUT. If activation mode is OTAA, this parameter value is used to generate a Join-accept message.

APPS_KEY

APPS_KEY is used to encrypt and verify application data between Gateway and End Device. This value is derived from APP_KEY during OTAA. If activation mode is ABP, this parameter must be set as the same value stored on the DUT.

NWKS_KEY

NWKS_KEY is used to encrypt and verify network data between Gateway and End Device. This value is derived from APP_KEY during OTAA. If activation mode is ABP, this parameter must be set as the same value stored on the DUT.

UPDATE_FCNT

This parameter determines the initial value of FCNT before activation procedure and also updates FCNT values after activation.

ADR

LoRa network allows the End Devices to individually use any of the possible data rates. This feature is used by LoRaWAN to adapt and optimize the data rate of static End Devices. This is referred to as

Adaptive Data Rate (ADR) and when this is enabled the network will be optimized to use the fastest data rate possible.

DOWNLINK_SLOT

When RWC5020A/B emulates Gateway/Server mode (EDT), it could respond to the uplink frame by downlink frame using RX1 window or RX2 window. Using this parameter, users can select the RX window for testing the DUT.

NET_ID

The NET_ID is a network identifier to uniquely identify the network. This parameter value is used to generate a Join-accept message.

RX1_DR_OFFSET

This parameter sets the offset between the uplink data rate and the downlink data rate used to communicate with the End Device on the first reception slot (RX1). This parameter value is used to generate a Join-accept message.

RX2_DR

This parameter defines the data rate of a downlink using the second receive window. This parameter value is used to generate a Join-accept message.

RECEIVE_DELAY

The first receive window RX1 opens RECEIVE_DELAY seconds after the end of the uplink modulation. This parameter value is used to generate a Join-accept message.

LINK_MARGIN

This parameter is an 8-bit unsigned integer in the range of 0~254 indicating the link margin in dB of the last successfully received *LinkCheckReq* command. This parameter value is used to generate *LinkCheckAns* command.

GATEWAY_CNT

This parameter is the number of gateways that successfully received the last *LinkCheckReq*. This parameter value is used to generate *LinkCheckAns* command.

YEAR

This parameter indicates the year of RWC5020A/B time information. This parameter is used to generate *DeviceTimeAns* command and Beacon.

MONTH

This parameter indicates the month of RWC5020A/B time information. This parameter is used to generate *DeviceTimeAns* command and Beacon.

DAY

This parameter indicates the day of RWC5020A/B time information. This parameter is used to generate *DeviceTimeAns* command and Beacon.

HOUR

This parameter indicates the hour of RWC5020A/B time information. This parameter is used to generate *DeviceTimeAns* command and Beacon.

MINUTE

This parameter indicates the minute of RWC5020A/B time information. This parameter is used to generate *DeviceTimeAns* command and Beacon.

SECOND

This parameter indicates the second of RWC5020A/B time information. This parameter is used to generate *DeviceTimeAns* command and Beacon.

NETWORK

This parameter indicates the type of LoRa network, in other words the synchronization word to be used in LoRa modulation.

3.1.3 RF Parameters

TX POW

This parameter defines the output power of RWC5020A/B in dBm.

RX_GAIN

The RWC5020A/B has an AGC (Automatic Gain Control) function. So the RWC5020A/B will set appropriate RX gain after receiving a few packets from the DUT. This parameter defines the initial RX gain when the Link is started. It is very important to set this parameter correctly to get the proper test result quickly. Set to LOW if the expected input level from your DUT to RWC5020A is higher than +12dBm. Set to HIGH if the expected input level is lower than -12dBm. Otherwise set it to MEDIUM. Set to LOWER if the expected input level from your DUT to RWC5020B is higher than +10dBm. Set to LOW if the expected input level from your DUT to RWC5020B is between +10dBm and -15dBm. Set to HIGH if the expected input level is lower than -40dBm. Otherwise set it to MEDIUM.

RX_GAIN_RANGE

This parameter shows the expected input level of the DUT depending on the RX_GAIN parameter. If the expected input range does not match the DUT output power, adjust the RX_GAIN parameter before starting the test.

RX_GAIN_WARNING_TO

If RWC502x does not receive RX packets for a while, RWC502x assumes that RX_GAIN may be incorrect and displays a notification. This parameter defines the timeout period for this notification.

PATH_LOSS

Users can set the path loss between the RF port of RWC5020A/B and DUT RF port. RWC5020A/B's real output power will be increased by this value to compensate for path loss.

SYSCLK_OFFSET

This parameter defines the system clock frequency (32MHz) offset value in ppm. It modifies RF frequency as well as LoRa modulation signal.

FREQ_OFFSET

This parameter defines the RF frequency offset value in ppm.

TIME_OFFSET

This parameter defines the time offset value in us.

CH_MASK_0

This parameter defines the mask of channels to be used for LoRa communication, which is

applicable only to regions of EU_868, EU_433, KR_920, AS_923, IN_865, and RU_865.

CH_GROUP

This parameter defines the mask of the channels to be used for LoRa communication, which is applicable only to regions of US_915, AU_915, and CN_470.

RX2_FREQ

This parameter defines the frequency of a downlink using the second receive window.

RX2_DR

This parameter defines the data rate of a downlink using the second receive window.

DL_CH_00 ~ DL_CH_07

This parameter defines the real channel frequency of each downlink channel index.

UL_CH_00 ~ UL_CH_07

This parameter defines the real channel frequency of each uplink channel index.

UL_CH_64 ~ UL_CH_71

This parameter defines the real channel frequency of each 500kHz uplink channel index.

3.2 Activation Procedure for EDT

3.2.1 Overview

RWC5020A/B supports both ways of activation of an End Device; Over The Air Activation (OTAA) and Activation By Personalization (ABP). This section describes how to configure parameters for OTAA and ABP respectively.

3.2.2 OTAA Procedure

1. [Parameter Window]

Press  key to open the parameter configuration screen and select PROTOCOL tab to configure MAC protocol parameters.

2. [Region]

Set the REGION parameter as needed.

3. [Protocol Version]

Set PROTOCOL_VER to LoRaWAN1.0.2, LoRaWAN1.0.3, LoRaWAN1.0.4 or LoRaWAN1.1.

4. [Activation Parameters]

For LoRaWAN V1.0.x,

1) Set the ACTIVATION parameter to OTAA.

2) Set APP_KEY to the application key specific to an End Device.

3) Set CHECK_EUI parameter to determine whether to check EUI of an End Device for activation.

If YES, both DEV_EUI and APP_EUI parameters shall be set to values specific to an End Device and RWC5020A/B will compare the EUI values with DUT and reject them if they do not match.

If NO, the RWC5020A/B copies these parameters from Join Accept packets. Therefore, users do not have to worry about these values.

4) Set SET_TEST_MODE parameter to determine whether to force the DUT into certification test

mode by sending an Activated Test Mode command after the activation procedure. For

LoRaWAN1.0.4, the TxPerChangeReq MAC command is used instead of the Activated Test Mode command.

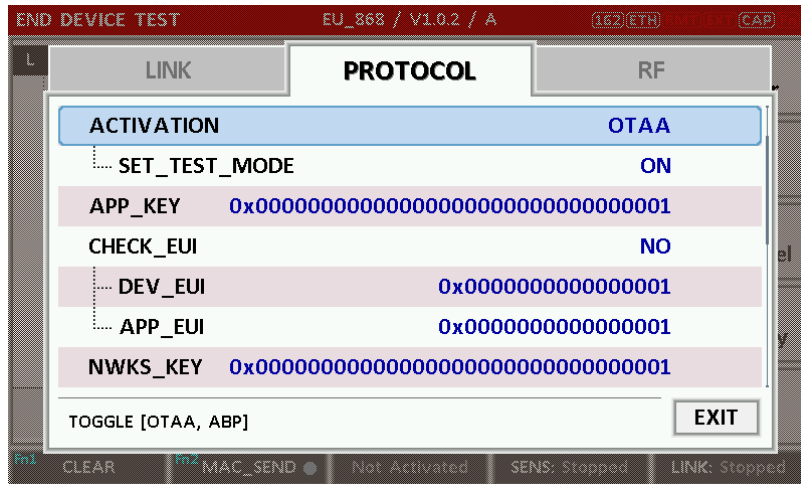

Fig 3.3 Parameters for OTAA (LoRaWAN V1.0)

For LoRaWAN V1.1,

- 1) Set the ACTIVATION parameter to OTAA.
- 2) Set NWK_KEY and APP_KEY parameters specific to an End Device.
- 3) Set CHECK_EUI parameter to determine whether to check EUI of an End Device for activation. If YES, both DEV_EUI and JOIN_EUI parameters shall be set to values specific to an End Device. If NO, these parameters are ignored in the activation procedure.
- 4) Set SET_TEST_MODE parameter to determine whether to force DUT to enter certification test mode by sending the TxPerChangeReq command after the activation procedure.

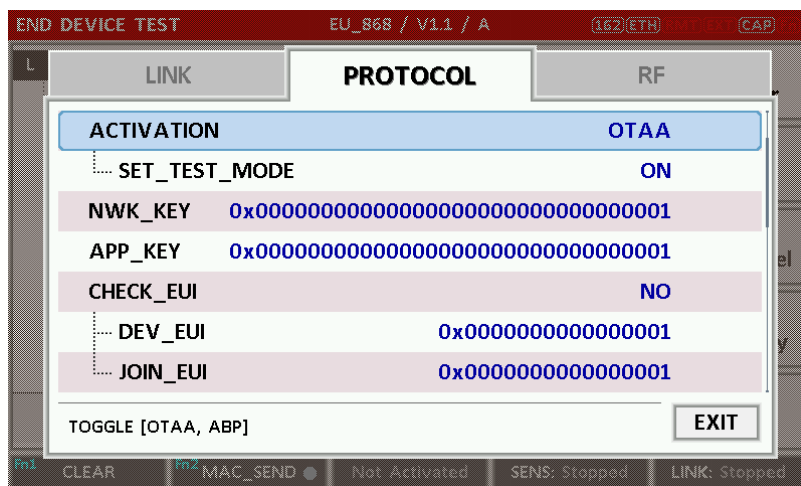

Fig 3.4 Parameters for OTAA (LoRaWAN V1.1)

5. [JoinAccept Parameters]

Set parameters of the Join-accept message if needed as the following figure.

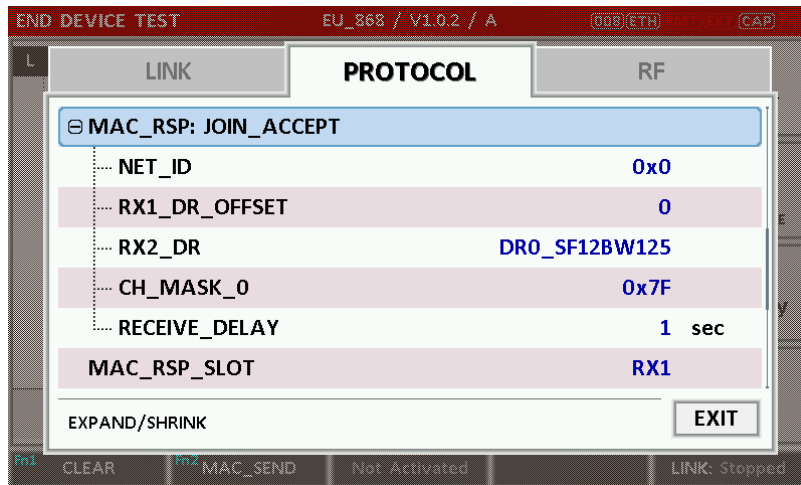

Fig 3.5 Parameters for Join-accept Message

6. [Downlink Slot]

Set MAC_RSP_SLOT parameter to RX1 or RX2 to determine a physical channel to be used for transmission by RWC5020A/B (Gateway/Server)

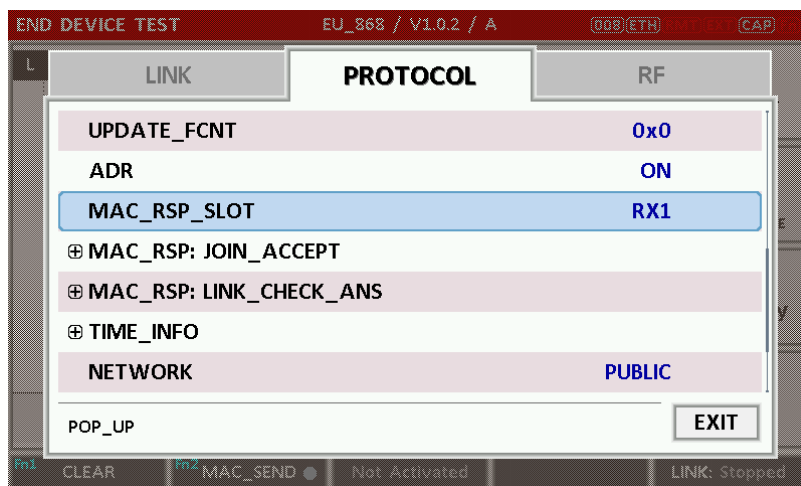

Fig 3.6 Selection of Downlink Slot

7. [RF Parameters Setup]

Select RF tab to configure RF parameters.

- 1) Set TX_POW and PATH_LOSS parameters if needed.
- 2) Set CH_MASK_0 or CH_GROUP to configure physical channels if needed. Then expand CHANNEL_INFO to configure channel information. This information is contained as CFLIST parameter of a Join-accept message.



Fig 3.7 Channel Information in RF Parameters

3.2.3 ABP Procedure

1. [Parameter Window]

Press **PARAM** key to open the parameter configuration screen and select PROTOCOL tab to configure MAC protocol parameters.
2. [Region]

Set the REGION parameter as needed.
3. [Protocol Version]

Set PROTOCOL_VER to LoRaWAN1.0.2, LoRaWAN1.0.3, LoRaWAN1.0.4 or LoRaWAN1.1.
4. [Activation Parameters]

For LoRaWAN V1.0.x,

 - 1) Set the ACTIVATION parameter to ABP.
 - 2) Set DEV_ADDR to a value specific to an End Device.
 - 3) Set NWKS_KEY and APPS_KEY parameters to the two session keys unique to an End Device.
 - 4) Set SET_TEST_MODE parameter to determine whether to force the DUT into certification test mode by sending an Activated Test Mode command after the activation procedure. For LoRaWAN1.0.4, the TxPerChangeReq MAC command is used instead of the Activated Test Mode command.

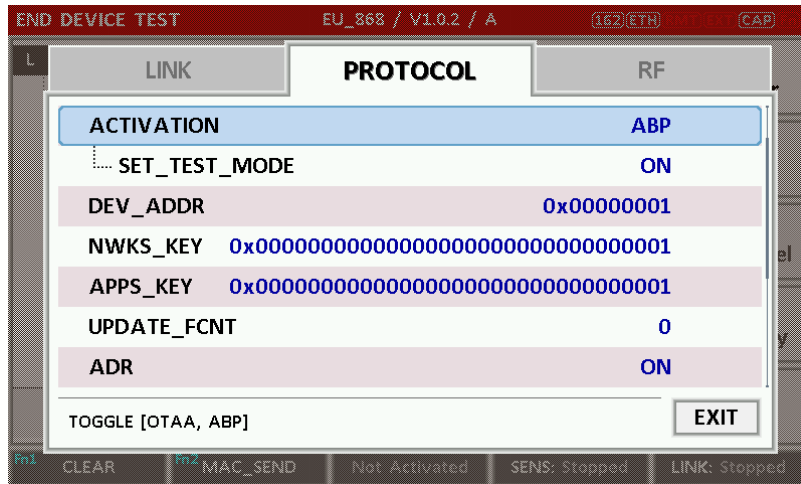

Fig 3.8 Parameters for ABP (LoRaWAN V1.0)

For LoRaWAN V1.1,

- 1) Set the ACTIVATION parameter to ABP.
- 2) Set DEV_ADDR to a value specific to an End Device.
- 3) Set FNWKS_IKEY, SNWKS_IKEY, NWKS_EKEY and APPS_KEY parameters to the four session keys unique to an End Device.
- 4) Set SET_TEST_MODE parameter to determine whether to force DUT to enter certification test mode by sending the TxPerChangeReq command after the activation procedure.

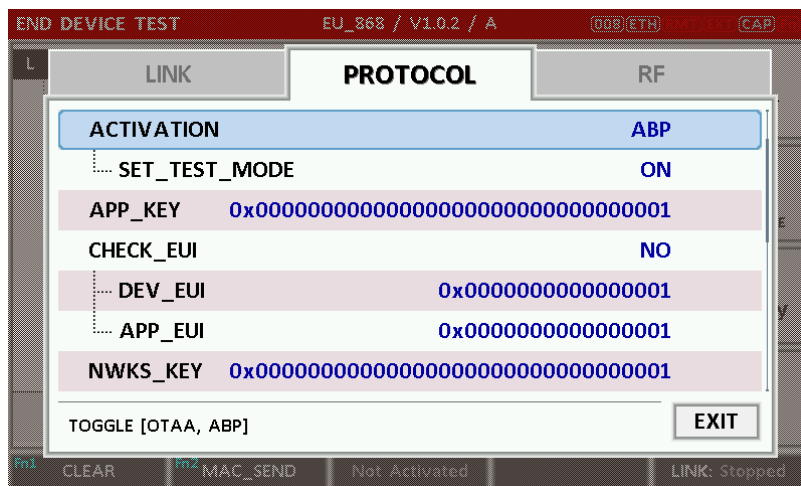

Fig 3.9 Parameters for ABP (LoRaWAN V1.1)

5. [RF Parameters Setup]









Refer to 3.2.2 for RF setup.

3.3 Usage of Link Analyzer for EDT

3.3.1 Overview

RWC5020A/B provides a function of Link Analyzer for EDT and GWT. In EDT, Link Analyzer helps to create a link between RWC5020A/B and an End Device Under Test and to analyze the protocol messages.

3.3.2 Test Procedure

1. [Main Menu selection]
Set the Main Menu to EDT referring to 2.3.1.
2. [Sub Menu selection]
Set the Sub Menu to Link Analyzer referring to 2.3.2.
3. [Parameter configuration]
Press  key to open the parameter configuration screen. Configure protocol parameters or RF parameters for users' purposes in PROTOCOL tab or RF tab respectively. Refer to 3.1 and 3.2 for details.
4. [DUT connection setup]
Connect the RF port of RWC5020A/B to the RF port of DUT with an RF cable for conduction test. For radiation tests, use a special test environment, e.g., a shield box or an antenna. In the latter case, it is recommended to use a test jig for DUT positioning to guarantee the reliability and repeatability of test and measurement results.
5. [Execution]
Press  key, and RWC5020A/B will be waiting for a message from the DUT. As soon as communication starts, link messages between DUT and RWC5020A/B will be displayed in real time. On the right bottom side of the screen the link status is displayed as 'LINK: Running' or 'LINK: Stopped'. Refer to 2.5.4 for descriptions of the Link Analyzer screen.
6. [Analysis and utilization]
Pressing  or  key moves the cursor location to the link message window. Rotating the rotary knob shows the raw data of the current cursor position at the bottom of the screen in hexa-decimal format. Rotating the rotary knob with  key pressed scrolls the screen by page-up or page-down. Pressing  or  key with  key pressed scrolls the screen in horizontal direction.
7. [Switch to other Sub Menu]
While the link status is running, switching to other Sub Menu is available. All data in Link Analyzer,

Power vs. Time, and Power vs. Channel are synchronized with each other, since RWC5020A/B analyzes protocol messages and also measures RF power in processing the received frames.

3.3.3 Parameters

RWC5020A/B provides a function of sending a MAC command to DUT, defined in the LoRaWAN Specification, at the time users want. All parameters for each MAC command are configurable. Refer to 3.7 for details.

MAC_CMD_TYPE

This parameter defines the type of MAC command to be transmitted: confirmed or unconfirmed.

MAC_CMD_FIELD

This parameter defines the type of field where MAC command is stored in a frame: payload or option field.

MAC_ANS_TO

This parameter defines MAC answer time-out after sending MAC command.

FOPTS_SIZE

This parameter defines the size of the FOpts field. This parameter is shown if MAC_CMD_FIELD is set as FOPTION.

FOPTS

This parameter defines the content of FOpts in hexadecimal format. This parameter is shown if MAC_CMD_FIELD is set as FOPTION.

NUM_OF_CMD

This parameter defines the number of MAC commands to be transmitted in a single frame. RWC5020A/B allows up to three MAC commands in a single frame.

INSTANT_MAC_CMD1 ~ 3

This parameter defines which MAC command will be transmitted.

INSTANT_MAC_CMD: DEV_STATUS

This parameter is for sending *DevStatusReq* command to DUT, which expects *DevStatusAns* command from it. *DevStatusReq* command requests the status of the End Device and does not have any parameters.

INSTANT_MAC_CMD: LINK_ADR

This parameter is for sending *LinkADRReq* command to DUT, which expects *LinkADRAns* command from it. *LinkADRReq* command requests the End Device to change data rate, transmit power, repetition rate or channel.

ADR_DR

This parameter is the requested data rate of End Device for uplink messages.

ADR_TXPOW

This parameter is the requested output power of End Device for uplink messages.

ADR_CH_MASK

This parameter encodes the channels usable for uplink access. A bit in the CH_MASK field set to 1 means that the corresponding channel can be used for uplink transmissions.

ADR_MASK_CTRL

This parameter controls the interpretation of the previously defined CH_MASK bit mask. It controls the block of 16 channels to which the CH_MASK applies. It can also be used to globally turn on or off all channels using specific modulation.

ADR_NB_TRANS

This parameter is the number of transmissions for each uplink message.

INSTANT_MAC_CMD: DUTY_CYCLE

This parameter is for sending *DutyCycleReq* command to DUT, which expects *DutyCycleAns* command from it. *DutyCycleReq* command sets the maximum aggregate transmit duty-cycle of the End Device.

MAX_DUTY_CYCLE

This parameter is used by the network coordinator to limit the maximum aggregate transmit duty cycle of an End Device.

INSTANT_MAC_CMD: RX_PARAM_SETUP

This parameter is for sending *RXParamSetupReq* command to DUT, which expects *RXParamSetupAns* command from it. *RXParamSetupReq* command sets the reception slots parameters.

RX1_DR_OFFSET

This parameter sets the offset between the uplink data rate and the downlink data rate used to communicate with the End Device on the first reception slot (RX1).

RX2_FREQ

This parameter defines the frequency of a downlink using the second receive window.

RX2_DR

This parameter defines the data rate of a downlink using the second receive window.

INSTANT_MAC_CMD: TX_PARAM_SETUP

This parameter is for sending *TXParamSetupReq* command to DUT, which expects *TXParamSetupAns* command from it. *TXParamSetupReq* command is used by the network server to set the maximum allowed dwell time and Max EIRP of End Device, based on local regulations.

MAX_EIRP

This parameter corresponds to an upper bound on the device’s radio transmit power. The device is not required to transmit at that power, but shall never radiate more than this specified EIRP.

Coded Value	0	1	2	3	4	5	6	7	8	9	10	11	12	13	14	15
Max EIRP (dBm)	8	10	12	13	14	16	18	20	21	24	26	27	29	30	33	36

UL_DWELL_TIME

This parameter corresponds to the maximum allowed dwell time for uplink transmissions.

DL_DWELL_TIME

This parameter corresponds to the maximum allowed dwell time for downlink transmissions.

INSTANT_MAC_CMD: NEW_CHANNEL

This parameter is for sending *NewChannelReq* command to DUT, which expects *NewChannelAns* command from it. *NewChannelReq* command creates or modifies the definition of a radio channel.

NEW_CH_MODE

This parameter can be used to either modify the parameters of an existing bidirectional channel or to create a new one. To create or modify the channel, set this parameter as ‘CREATE’. To delete the channel, set this parameter as ‘DELETE’

NEW_CH_INDEX

This parameter is the index of the channel being created or modified.

NEW_CH_MAX_DR

This parameter designates the highest uplink data rate allowed on this channel.

NEW_CH_MIN_DR

This parameter designates the lowest uplink data rate allowed on this channel.

INSTANT_MAC_CMD: DL_CHANNEL

This parameter is for sending *DChannelReq* command to DUT, which expects *DChannelAns* command from it. *DChannelReq* command sets the network to associate a different downlink frequency to the RX1 slot.

DL_CH_INDEX

This parameter is the index of the channel whose downlink frequency is modified.

DL_CH_FREQ

This parameter is the corresponding downlink frequency value of a 24 bits unsigned integer. The actual downlink frequency in Hz is 100 x DL_CH_FREQ.

INSTANT_MAC_CMD: RX_TIMING_SETUP

This parameter is for sending *RXTimingSetupReq* command to DUT, which expects *RXTimingSetupAns* command from it. *RXTimingSetupReq* command sets the timing of the reception slots.

RECEIVE_DELAY

The first receive window RX1 opens RECEIVE_DELAY seconds after the end of the uplink modulation.

INSTANT_MAC_CMD: USER_DEFINED

This parameter is for sending a user-defined command to DUT, which includes user-defined data of user-defined length.

FPORT

This parameter defines the FPort number of a user-defined MAC Command.

PAYLOAD_SIZE

This parameter defines the size of payload of a user-defined MAC Command.

PAYLOAD

This parameter defines the content of the payload in hexadecimal format.

INSTANT_MAC_CMD: BEACON_FREQ

This parameter is for sending *BeaconFreqReq* command to DUT, which expects *BeaconFreqAns* command from it. *BeaconFreqReq* command sets the network to associate new beacon frequency

BEACON_FREQ

This parameter is the corresponding beacon frequency value of a 24 bits unsigned integer.

INSTANT_MAC_CMD: PING_SLOT_CH_REQ

This parameter is for sending *PingSlotChannelReq* command to DUT, which expects *PingSlotFreqAns* command from it. *PingSlotChannelReq* command modifies the frequency and/or the data rate on which the end-device expects the downlink pings

PING_DR

This parameter is the index of the Data Rate used for the ping-slot downlinks.

PING_FREQ

This parameter is the corresponding ping channel frequency value of a 24 bits unsigned integer. The actual ping channel frequency in Hz is $100 \times \text{PING_FREQ}$.

INSTANT_MAC_CMD: FORCE_REJOIN

This parameter is for sending *ForceRejoinReq* to DUT, which expects no answer from it. With the *ForceRejoinReq* command, the network asks a device to immediately transmit a Rejoin-Request Type 0 or type 2 message with a programmable number of retries, periodicity and data rate.

REJOIN_DR

This parameter is the data rate of Rejoin-Request.

REJOIN_TYPE

This parameter is the type of Rejoin-Request.

REJOIN_RETRY

This parameter is the total number of times DUT will retry Rejoin-Request.

REJOIN_PERIOD

This parameter is the delay between retransmissions. The actual delay is $32 \times 2^{\text{Period}} + \text{Rand32}$ seconds, where Rand32 is a pseudo-random number in the [0:32] range.

INSTANT_MAC_CMD: REJOIN_SETUP

This parameter is for sending *RejoinParamSetupReq* command to DUT, which expects *RejoinParamSetupAns* command from it. *RejoinParamSetupReq* command sets the network to request DUT to periodically send a *RejoinReq* Type 0 message with a programmable periodicity defined as a time of a number of uplinks.

REJOIN_MAX_TIME_N

This parameter is the max time T. DUT must send a Rejoin-Request Type 0 at least every 2^{T+10} seconds.

REJOIN_MAX_CNT_N

This parameter is the max count C. DUT must send a Rejoin-Request Type 0 at least every 2^{C+4} uplink messages.

INSTANT MAC CMD: ADR SETUP

This parameter is for sending *ADRParamSetupReq* command to DUT, which expects *ADRParamSetupAns* command from it. *ADRParamSetupReq* command allows changing the ADR_ACK_LIMIT and ADR_ACK_DELAY parameters defining the ADR back-off algorithm.

ADR_LIMIT_EXP

This parameter is used to set ADR_ACK_LIMIT parameter value:

$$\text{ADR_ACK_LIMIT} = 2^{\text{ADR_LIMIT_EXP}}$$

ADR_DELAY_EXP

This parameter is used to set ADR_ACK_DELAY parameter value:

$$\text{ADR_ACK_DELAY} = 2^{\text{ADR_DELAY_EXP}}$$

DOWNLINK_SLOT

When RWC5020A/B emulates Gateway/Server mode (EDT), it could respond to the uplink frame by downlink frame using RX1 window or RX2 window. Using this parameter, users can select the RX window for testing the DUT.

PERIODIC DOWNLINK

This parameter defines the periodic downlink of RWC5020A/B after the activation procedure finishes. The type of periodic downlink can be NONE, CONFIRMED_DOWN, or UNCONFIRMED_DOWN. There is no interval parameter in the periodic downlink function, because the downlink message can only be sent when a packet is received from the end device.

PERIODIC_FPORT

This parameter defines the FPort number of a user-defined MAC Command.

PERIODIC_PLD_SIZE

This parameter defines the size of payload of a user-defined MAC Command.

MAL_FUNCTION

Using these parameters, you can generate abnormal packets.

MIC_ERROR

This parameter determines whether to generate packets with intentional MIC error.

MHDR_ERROR

This parameter is used for an exclusive OR on the MAC Header to generate abnormal packets.

FHDR_ERROR

This parameter is used for an exclusive OR on the Frame Header to generate abnormal packets.

MIC_ERR_DISPLAY

This parameter determines whether to display erroneous frames in the Link Analyzer screen.

PARAMETER_DISPLAY





This parameter determines the list of protocol parameters to be displayed on the Link Analyzer screen. Each parameter can be switched on or off; DR, POW, TIME, DELAY, FCNT, ADR, ACK, ADRACKREQ, FPENDING, CLASS_B, PORT, DWELL and MSG_TYPE.

3.4 Usage of Power Measure for EDT

3.4.1 Overview

RWC5020A/B provides a function of Power measurement for EDT and GWT. In EDT, RWC5020A/B has Power vs. Time and Power vs. Channel measurements which help to create a link between RWC5020A/B and an End Device Under Test and to measure the received power with respect to data rates.

3.4.2 Test Procedure

1. [Main Menu selection]
Set the Main Menu to EDT referring to 2.3.1.
2. [Sub Menu selection]
Set the Sub Menu to Power Measure referring to 2.3.2.
3. [Parameter configuration]
Press  key to open the parameter configuration screen. Configure protocol parameters or RF parameters for users' purposes in PROTOCOL tab or RF tab respectively. Refer to 3.1 and 3.2 for details.
4. [DUT connection setup]
Connect the RF port of RWC5020A/B to the RF port of DUT with an RF cable for conduction test. For radiation tests, use a special test environment, e.g., a shield box or an antenna. In the latter case, it is recommended to use a test jig for DUT positioning to guarantee the reliability and repeatability of test and measurement results.
5. [Execution]
Press  key, and RWC5020A/B will be waiting for a message from the DUT. As soon as communication starts, the measured power will be displayed on the screen in real time. On the right bottom side of the screen the link status is displayed as 'LINK: Running' or 'LINK: Stopped'. Refer to 2.5.5 for descriptions of the Power Measure screen.
6. [Analysis and utilization]
In Power vs. Time mode, Pressing  or  key moves the cursor location to the measurement window, and the cursor changes to the marker. Rotating the rotary knob shows all measured values of the current marker position at the top of the screen.
7. [Switch to other Sub Menu]
While the link status is running, switching to other Sub Menu is available. All data in Link Analyzer, Power Measure are synchronized with each other, since RWC5020A/B analyzes protocol messages and also measures RF power in processing the received frames.

3.4.3 Parameters

MODE

It determines the test method of Power Measurement. If it is set at SYNC_TO_LINK, Power measurement is fully synchronized with Link Analyzer. Power Measure displays all Received packets while Link Analyzer is running. If it is set as SCENARIO, Power Measure function measures TX power of DUT using special scenarios which is selected by SCENARIO parameter. This measurement is started by pushing  key on Power Measure Screen.

SCENARIO

It has three different scenarios to activate DUT to measure power of DUT. NORMAL_UL scenario mode just receives any packet from DUT and measures the power. The CERTI_DL_CNT scenario will set the DUT as Test mode at the beginning stage and measure the power of DL_Counter packets from DUT. CERTI_CW scenario will set the DUT as Test mode and transmit CW_ENABLE MAC command to transmit CW signal by DUT and measure this CW signal power. If you are using RWC5020B, this scenario mode also measures CW frequency value.

UL_DR

This parameter is the requested data rate of End Device for uplink messages.

ADR_POWER

This parameter is the requested output power of End Device for uplink messages.

TARGET_CH_MASK

This parameter encodes the channels usable for uplink access. A bit in the CH_MASK field set to 1 means that the corresponding channel can be used for uplink transmissions.

PKT_NUM

This parameter defines the minimum packet number for power measurement on each channel which is defined by TARGET_CH_MASK.

CW_TIMEOUT

This parameter indicates the timeout for CW transmission.

CW_FREQ

This parameter indicates the frequency of CW signal.

CW_POW





This parameter indicates the power of CW signal.

3.5 Usage of Receiver Sensitivity for EDT

3.5.1 Overview

Receiver Sensitivity is a function of testing the receiver performance of DUT. RWC5020A/B sweeps its power level from the start value to the stop value with the step value and checks whether DUT functions properly, and stops immediately after DUT does not function properly.

3.5.2 Test Procedure

1. [Main Menu selection]
Set the Main Menu to EDT referring to 2.3.1.
2. [Sub Menu selection]
Set the Sub Menu to Receiver Sensitivity referring to 2.3.2.
3. [Parameter configuration]
Press  key to open the parameter configuration screen. Configure protocol parameters or RF parameters for users' purposes in PROTOCOL tab or RF tab respectively. Refer to 3.1 and 3.2 for details. In the SENSITIVITY tab, all parameters can be configured to be used in the execution of sensitivity tests.
4. [DUT connection setup]
Connect the RF port of RWC5020A/B to the RF port of DUT with an RF cable for conduction test. For radiation tests, use a special test environment, e.g., a shield box or an antenna. In the latter case, it is recommended to use a test jig for DUT positioning to guarantee the reliability and repeatability of test and measurement results.
5. [Execution]
Press  key, and RWC5020A/B will be waiting for a message for activation from the DUT. As soon as the activation procedure finishes, RWC5020A/B starts the sensitivity test from the start power value, checks whether DUT functions properly at each power step value, stops immediately after DUT does not function properly, and shows the final results. On the right bottom side of the screen the sensitivity status is displayed as 'SENS: Running' or 'SENS: Stopped' as well as the link status. Refer to 2.5.7 for descriptions of the Receiver Sensitivity screen.
6. [Analysis and utilization]
Pressing  or  key moves the cursor location to the sensitivity window, and the cursor changes to the marker. Rotating the rotary knob shows all measured values of the current marker position at the top of the screen.
7. [Switch to other Sub Menu]
While the sensitivity status is running, switching to the other Sub Menu is available. All data in Link

Analyzer, Power vs. Time, and Power vs. Channel are synchronized with each other, since RWC5020A/B analyzes protocol messages and also measures RF power in processing the received frames.

3.5.3 Parameters

SCENARIO

This is the test scenario of the sensitivity test. In 'NORMAL_UL', DUT should send unconfirmed or confirmed uplink messages periodically and the Tester sends confirmed downlink messages and checks the flag of acknowledgement in DUT frames in order to count errors. In 'CERTI_ECHO', DUT should enter the test mode by the Tester's activation command and the Tester will use EchoRequest/EchoResponse in order to count errors. In 'CERTI_DL_CNT', DUT should enter the test mode by the Tester's activation command and the Tester will use DL_Counter value in order to count errors. CERTI_ECHO and CERTI_DL_CNT are not available in LoRaWAN 1.0.4 or later.

PACKET_NUM

This is the packet number of tests at each test point. Increasing the value increases the resolution of the test results, but may increase the test time.

START_POW

This defines the start value of POWER sweep.

STOP_POW

This defines the stop value for POWER sweep (read only).

STEP_POW

This defines the step value for POWER sweep.

NUM_POW

This defines the number of power values for POWER sweep.

TARGET_PER

This is a parameter to set the user's target PER. The test sweeps fully in the range of POWER until DUT does not satisfy TARGET_PER.

TARGET_CH_MASK

This parameter encodes the channels usable for uplink access. A bit in the CH_MASK field set to 1 means that the corresponding channel can be used for uplink transmissions.

DOWNLINK_SLOT

This is a parameter to select the RX window for testing the DUT.

TARGET_DR

This is a parameter to determine the DR by sending MAC commands before the Sensitivity Test starts. *LinkADDRReq* will be sent in case of RX1 and *RXParamSetReq* will be sent in case of RX2.

DL_PACKET

This is a parameter to define the contents of downlink packets to be used in the 'NORMAL_UL' scenario.

FPORT

This parameter defines the FPort number of a user-defined MAC Command.

PAYLOAD_SIZE

This parameter defines the size of payload of a user-defined MAC Command.

PAYLOAD

This parameter defines the content of the payload in hexadecimal format.

3.6 Transmission of MAC Commands for EDT

3.6.1 Overview

After the activation procedure is completed successfully, RWC5020A/B can send any MAC command to DUT as defined on Parameter configuration.

3.6.2 Test Procedure

1. [Activation]

Follow the steps referring to 3.3 to complete the activation successfully.

2. [MAC command selection]

Press **PARAM** key to open the parameter configuration screen and move to LINK tab. Define the number of MAC commands to be sent in a single frame as NUM_OF_CMD and select a MAC command to be sent from the list of INSTANT_MAC_CMD and configure its parameters. Refer to 3.3.3 for details about MAC commands. Close the parameter configuration screen.

3. [MAC command transmission]

Press **Fn** + **2 B** key to select 'MAC_SEND' button on the bottom of the screen. Then RWC5020A/B will wait for a new message from DUT to send the MAC command at the next downlink channel.

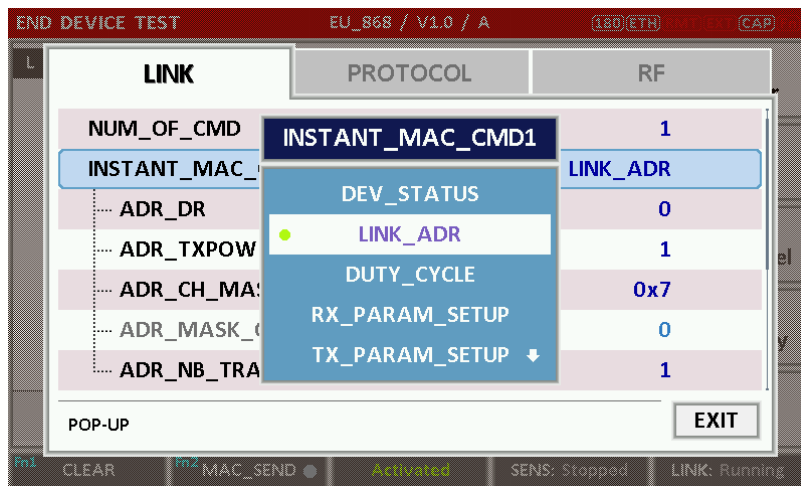

Fig 3.10 Example of a single MAC command selection

END DEVICE TEST											EU_868 / V1.0.2 / A		008 ETH RNDTEXT CAP FN		
L	CH	DR	SF	BW	Pow	Time	FCnt	AckPort	M	dwell	CMD	Link Analyzer			
U	0	0	12	125	12.6	5.00s	0017	0	224	U	1155	DICounter(0)			
U	1	0	12	125	12.7	5.00s	0018	0	224	U	1155	DICounter(0)			
U	0	0	12	125	12.7	5.00s	0019	0	224	U	1155	DICounter(0)			
U	0	0	12	125	12.7	5.00s	001A	0	224	U	1155	DICounter(0)			
U	0	0	12	125	12.7	5.00s	001B	0	224	U	1155	DICounter(0)			
U	2	0	12	125	12.6	5.00s	001C	0	224	U	1155	DICounter(0)			
U	0	0	12	125	12.7	5.00s	001D	0	224	U	1155	DICounter(0)			
D	0	0	12	125	-30.0	----	0001	0	000	U	1318	LinkADRReq			
U	2	2	10	125	10.4	4.18s	001E	0	224	U	329	{LinkADRAns}			
U	1	2	10	125	10.4	5.00s	001F	0	224	U	329	DICounter(1)			
Pow=1,DR=2,Mask=0007h,MC=0,NbTrans=1															
60 01 00 00 00 80 01 00 00 03 21 07 00 01 34 BC 92 A8															
Fn1 CLEAR		Fn2 MAC_SEND		Activated		LINK: Running									

Fig 3.11 Example of a single MAC command transmission (Fn + 2 B)

END DEVICE TEST											EU_868 / V1.0.2 / A		008 ETH RNDTEXT CAP FN	
LINK											PROTOCOL		RF	
INSTANT_MAC_CMD1											RX_PARAM_SETUP			
RX1_DR_OFFSET											0			
RX2_FREQ											869.525000		MHz	
RX2_DR											DR0_SF12BW125			
INSTANT_MAC_CMD2											LINK_ADR			
ADR_DR											DR0_SF12BW125			
ADR_TXPOW											1			
POP-UP											EXIT			
Fn1 CLEAR		Fn2 MAC_SEND		Activated		LINK: Running								

Fig 3.12 Example of multiple MAC commands selection

END DEVICE TEST											EU_868 / V1.0.2 / A		008 ETH RNDTEXT CAP FN		
L	CH	DR	SF	BW	Pow	Time	FCnt	AckPort	M	dwell	CMD	Link Analyzer			
U	0	0	12	125	12.6	5.00s	000A	0	224	U	1155	DICounter(0)			
U	3	0	12	125	12.7	5.01s	000B	0	224	U	1155	DICounter(0)			
D	3	0	12	125	-30.0	----	0001	0	000	U	1482	RXParamSetReq			
D												LinkADRReq			
U	1	0	12	125	10.4	5.17s	000C	0	224	U	1318	{RXParamSetAns}			
U												{LinkADRAns}			
U	1	0	12	125	10.4	5.00s	000D	0	224	U	1318	{RXParamSetAns}			
D	1	0	12	125	-30.0	----	0002	0	000	U	991	NoPayload			
U	1	0	12	125	10.4	4.84s	000E	0	224	U	1155	DICounter(2)			
U	0	0	12	125	10.4	5.01s	000F	0	224	U	1155	DICounter(2)			
RX1DRoffset=0,RX2DR=0,RX2FREQ=869.525															
Fn1 CLEAR		Fn2 MAC_SEND		Activated		LINK: Running									

Fig 3.13 Example of multiple MAC commands transmission (Fn + 2 B)

3.7 Usage of Link Analyzer for Class B EDT

3.7.1 Overview

This section shows how to connect Class B End Device and configure related parameters.

3.7.2 Test Procedure

1. [Parameter Configuration]

Press **PARAM** key to open the parameter configuration screen and move to PROTOCOL tab. Select CLASS as B. Then read-only parameters appear such as PING_PERIODICITY and PING_DR, which may be updated by DUT parameters.

2. [Activation]

Refer to 3.2 to configure parameters for activation.

3. [Execution]

Press **RUN** key, and RWC5020A/B will be waiting for a message for activation from the DUT. As soon as the activation procedure finishes, RWC5020A/B starts the beacon timer, which counts up every second from 0 to 127, shown as RUN_xx at the right bottom of the screen. Whenever the timer sets to zero, a beacon is sent out. The following figure is an example of communication between Class B End Device and RWC5020A/B, showing related MAC commands and Class B flag.

4. [MAC command transmission through PING slot]

Press **PARAM** key to open the parameter configuration screen and move to LINK tab. Select DOWNLINK_SLOT as PING. The selected MAC command will be sent at the next PING slot. Refer to 3.7 for details of MAC command transmission, which is also applicable to Class B.

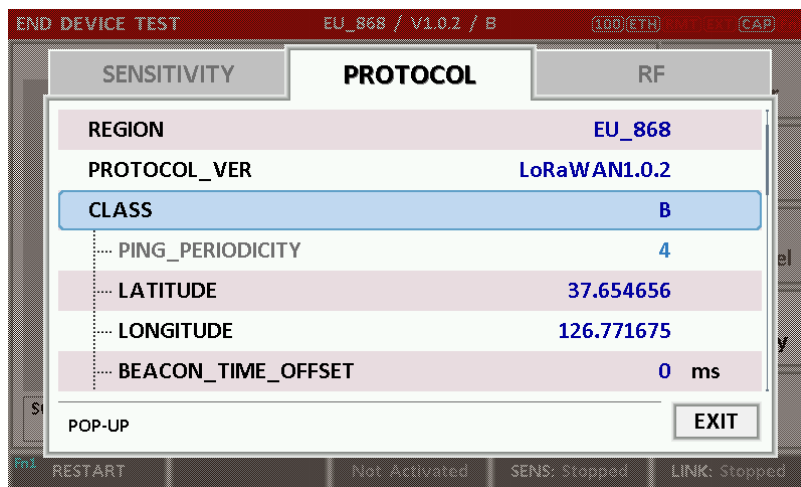

Fig 3.14 Selection of Class B in Parameter Configuration



Fig 3.15 Example of communication with Class B End Device

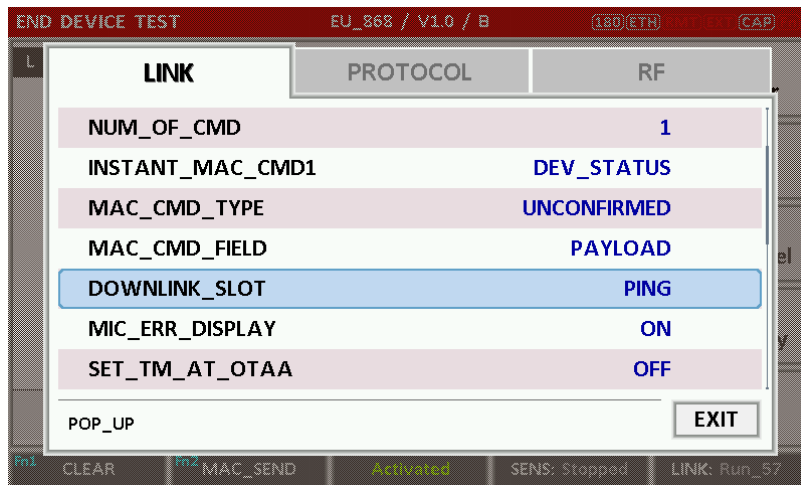

Fig 3.16 Selection of DOWNLINK_SLOT



Fig 3.17 MAC command transmission through PING slot

- [Send periodic Downlink message through PING slot]

Press **PARAM** key to open the parameter configuration screen and move to LINK tab. Select PERIODIC_DOWNLINK as CONFIRMED_DOWN or UNCONFIRMED_DOWN to transmit downlink messages periodically.

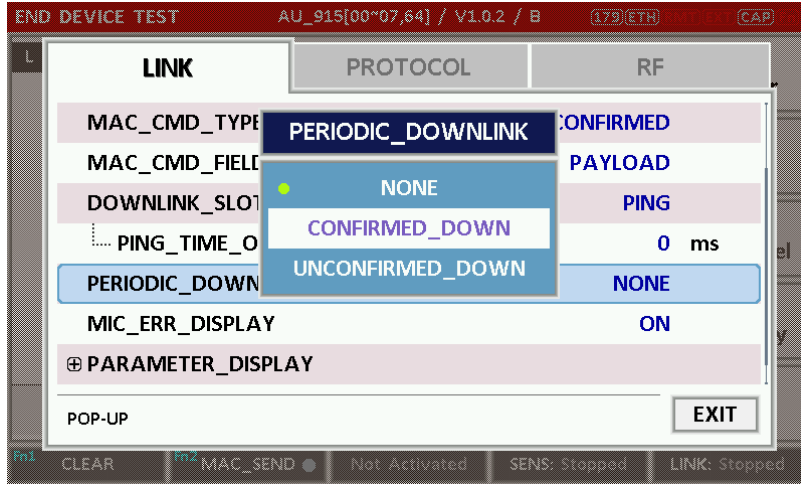

Fig 3.18 Selection of Periodic downlink mode in Parameter Configuration

3.8 Parameter Configuration and Basic Setup for GWT

3.8.1 Overview

To create a link with a Gateway and measure its performances, various protocol parameters as well as RF parameters should be configured in advance for users' purposes. This configuration is done in the parameter configuration screen as the following figure. Refer to 3.8.2 and 3.8.3 for descriptions of parameters.

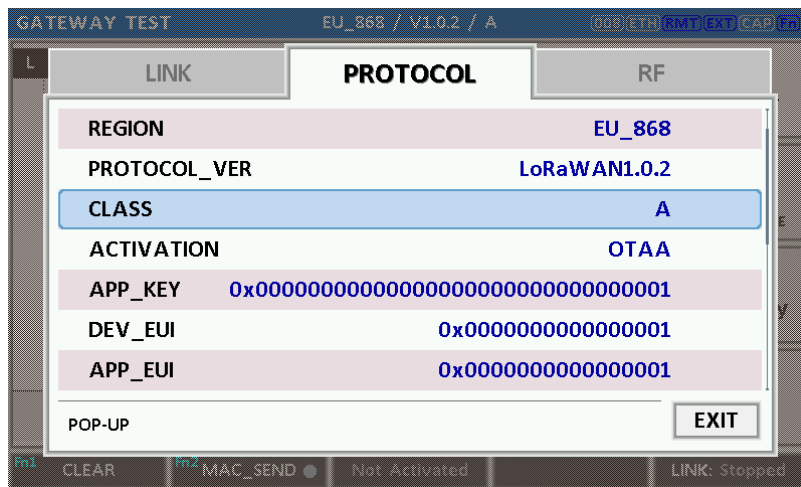

Fig 3.19 GWT Parameter Configuration Screen - PROTOCOL



Fig 3.20 GWT Parameter Configuration Screen - RF

3.8.2 PROTOCOL Parameters

REGION

RWC5020A/B supports various regions [EU 868, EU 433, US 915, AU 915, CN 470, KR 920, AS 923, IN 865, and RU 864]. Using this parameter, the user could select the region to test.

PROTOCOL_VER

This parameter defines the version of LoRaWAN protocol to be emulated by RWC5020A/B.

CLASS

There are three different classes in LoRa devices. Class A is Bi-directional End Devices, Class B is Bi-directional End Devices with scheduled receive slots, and Class C is Bi-directional End Devices with maximal receive slots. This parameter defines the class mode of RWC5020A/B.

ACTIVATION

LoRaWAN defines two types of Activation procedures (OTAA, ABP). This parameter defines the activation mode of RWC5020A/B.

APP_KEY

The APP_KEY is an AES-128 root key specific to the End Device. Whenever an End Device joins a network via over-the-air activation, the APP_KEY is used to derive the session keys NwksKey and AppSKey specific for that End Device to encrypt and verify network communication and application data. This parameter must be set to the same value as the APP_KEY on DUT.

DEV_EUI

The DEV_EUI is a globally unique End Device identifier. The DEV_EUI is stored in the End Device before the activation procedure is executed. If the CHECK_EUI is ON, this parameter must be set as the same value stored on the DUT.

APP_EUI

The APP_EUI is a global application ID in IEEE EUI64 address space that uniquely identifies the entity able to process the Join-request frame. The APP_EUI is stored in the End Device before the activation procedure is executed. If the CHECK_EUI is ON, this parameter must be set as the same value stored on the DUT.

NET_ID

The NET_ID is a network identifier to uniquely identify the network.

DEV_ADDR

During the activation, the gateway assigns DEV_ADDR value to the End Device. If activation mode is ABP, this parameter must be set as the same value stored on the DUT.

APPS_KEY

APPS_KEY is used to encrypt and verify application data between Gateway and End Device. This value is derived from APP_KEY during OTAA. If activation mode is ABP, this parameter must be set as the same value stored on the DUT.

NWKS_KEY

NWKS_KEY is used to encrypt and verify network data between Gateway and End Device. This value is derived from APP_KEY during OTAA. If activation mode is ABP, this parameter must be set as the same value stored on the DUT.

UPDATE_FCNT

This parameter determines the initial value of FCNT before activation procedure and also updates FCNT values after activation.

ADR

LoRa network allows the End Devices to individually use any of the possible data rates. This feature is used by LoRaWAN to adapt and optimize the data rate of static End Devices. This is referred to as Adaptive Data Rate (ADR) and when this is enabled the network will be optimized to use the fastest data rate possible.

DOWNLINK_SLOT

When RWC5020A/B emulates End Device mode (GWT), it could receive a downlink frame through RX1 channel and/or RX2 channel. Using this parameter, users can select the RX channel for testing the DUT.

UPLINK_DR

This parameter defines the data rate of the uplink channel.

BATTERY

This parameter defines the battery level to be reported by *DevStatusAns* command.

SNR_MARGIN

This parameter defines the demodulation SNR ratio in dB rounded to the nearest integer value for the last successfully received *DevStatusReq* command to be reported by *DevStatusAns* command.

NETWORK

This parameter indicates the type of LoRa network, in other words the synchronization word to be used in LoRa modulation.

3.8.3 RF Parameters

TX_POW

This parameter defines the output power of RWC5020A/B in dBm.

RX_GAIN

The RWC5020A/B has an AGC (Automatic Gain Control) function. So the RWC5020A/B will set appropriate RX gain after receiving a few packets from the DUT. This parameter defines the initial RX gain when the Link is started. It is very important to set this parameter correctly to get the proper test result quickly. Set to LOW if the expected input level from your DUT to RWC5020A is higher than +12dBm. Set to HIGH if the expected input level is lower than -12dBm. Otherwise set it to MEDIUM. Set to LOWER if the expected input level from your DUT to RWC5020B is higher than +10dBm. Set to LOW if the expected input level from your DUT to RWC5020B is between +10dBm and -15dBm. Set to HIGH if the expected input level is lower than -40dBm. Otherwise set it to MEDIUM.

RX_GAIN_RANGE

This parameter shows the expected input level of the DUT depending on the RX_GAIN parameter. If the expected input range does not match the DUT output power, adjust the RX_GAIN parameter before starting the test.

PATH_LOSS

Users can set the path loss between the RF port of RWC5020A/B and DUT RF port. RWC5020A/B's real output power will be increased by this value to compensate for path loss.

SYSCLK_OFFSET

This parameter defines the system clock frequency (32MHz) offset value in ppm. It modifies RF frequency as well as LoRa modulation signal.

FREQ_OFFSET

This parameter defines the frequency offset value in ppm.

CH_MASK_0

This parameter defines the mask of channels to be used for LoRa communication, which is applicable only to EU 868, EU 433, KR 920, AS 923, IN 865 and RU 864.

CH_MASK_0 ~ CH_MASK_4

These parameters define the masks of channel groups to be used for LoRa communication, which are applicable only to US 915 and AU 915, and CH_MASK_0 is the mask for the lowest channels.

CH_MASK_0 ~ CH_MASK_5

These parameters define the masks of channel groups to be used for LoRa communication, which are applicable only to CN 470, and CH_MASK_0 is the mask for the lowest channels.

RX2_FREQ

This parameter defines the frequency of a downlink using the second receive window (read only).

RX2_DR

This parameter defines the data rate of a downlink using the second receive window (read only).

DL_CH_00 ~ DL_CH_xx

This parameter defines the real channel frequency of each downlink channel index (read only). The maximum index depends on the REGION parameter.

UL_CH_00 ~ UL_CH_xx

This parameter defines the real channel frequency of each uplink channel index (read only). The maximum index depends on the REGION parameter.

ADR_POW_CTRL

This parameter defines whether to control the output power of RWC5020A/B with the LinkADRReq command.

3.9 Activation Procedure for GWT

3.9.1 Overview

RWC5020A/B supports both ways of activation of an End Device; Over The Air Activation (OTAA) and Activation By Personalization (ABP). This section describes how to configure parameters for OTAA and ABP respectively.

3.9.2 OTAA Procedure

1. [Parameter Window]

Press **PARAM** key to open the parameter configuration screen and select PROTOCOL tab to configure MAC protocol parameters.
2. [Region]

Set the REGION parameter as needed.
3. [Protocol Version]

Set PROTOCOL_VER to LoRaWAN1.0.2, LoRaWAN1.0.3, LoRaWAN1.0.4, or LoRaWAN1.1.
4. [Activation Parameters]

LoRaWAN V1.0.x,

 - 1) Set the ACTIVATION parameter to OTAA.
 - 2) Set APP_KEY to the application key specific to an End Device (RWC5020A/B), which shall be registered into the Network Server.
 - 3) Set DEV_EUI and APP_EUI parameters to values specific to an End Device (RWC5020A/B), which shall be registered into the Network Server.

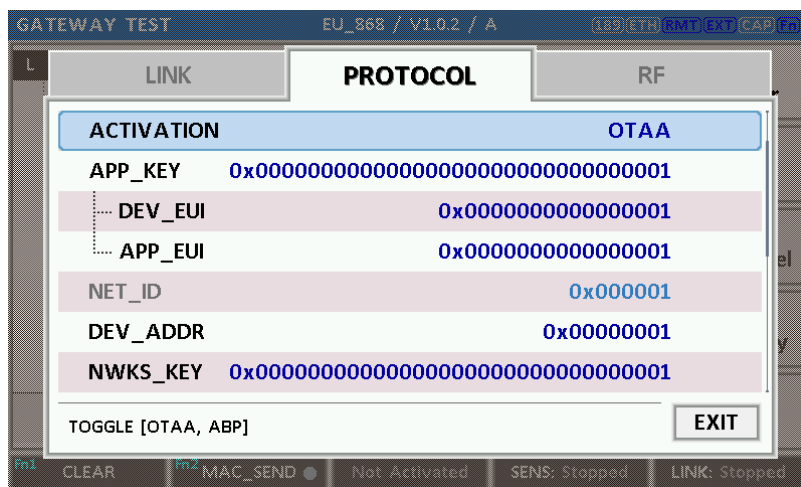

Fig 3.21 Parameters for OTAA (LoRaWAN V1.0)

LoRaWAN V1.1,

- 1) Set the ACTIVATION parameter to OTAA.
- 2) Set NWK_KEY and APP_KEY parameters specific to an End Device (RWC5020A/B), which shall be registered into the Network Server.
- 3) Set DEV_EUI and JOIN_EUI parameters to values specific to an End Device (RWC5020A/B), which shall be registered into the Network Server.

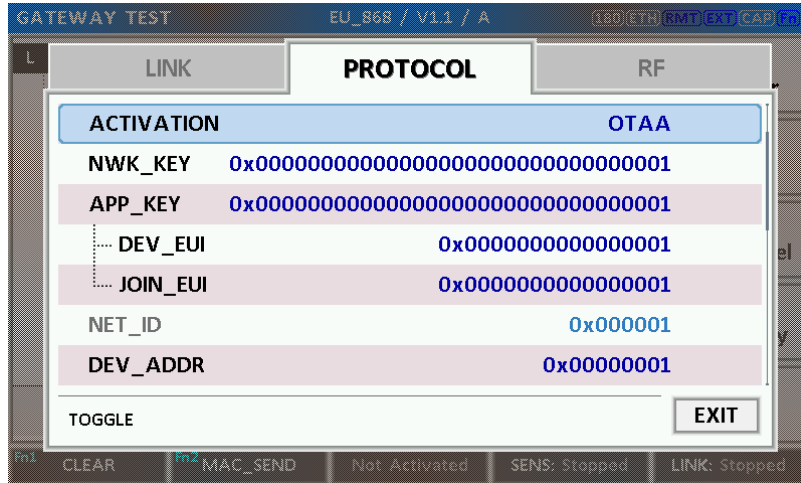

Fig 3.22 Parameters for OTAA (LoRaWAN V1.1)

5. [RF Parameters Setup]

Select RF tab to configure RF parameters.

- 1) Set TX_POW and PATH_LOSS parameters if needed.
- 2) Expand CHANNEL_INFO to configure channel information. And set UPLINK_DR if necessary.

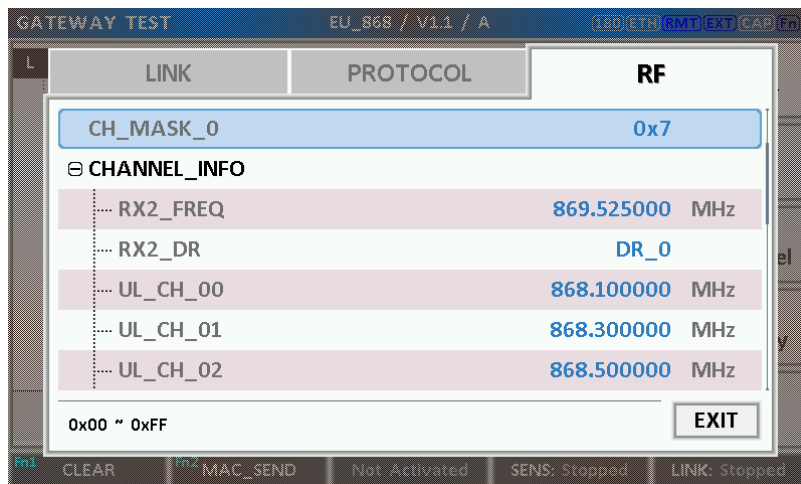

Fig 3.24 Channel Information in RF Parameters

3.9.3 ABP Procedure

1. [Parameter Window]

Press **PARAM** key to open the parameter configuration screen and select PROTOCOL tab to configure MAC protocol parameters.
2. [Region]

Set the REGION parameter as needed.
3. [Protocol Version]

Set PROTOCOL_VER to LoRaWAN1.0, LoRaWAN1.0.3, LoRaWAN1.0.4 or LoRaWAN1.1
4. [Activation Parameters].

For LoRaWAN V1.0.x,

 - 1) Set the ACTIVATION parameter to ABP.
 - 2) Set DEV_ADDR to a value specific to an End Device.
 - 3) Set NWKS_KEY and APPS_KEY parameters to the two session keys unique to an End Device.

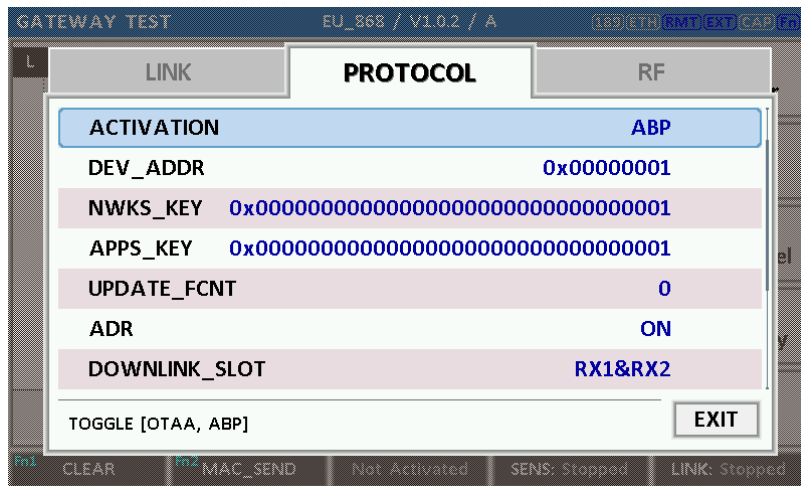

Fig 3.25 Parameters for ABP (LoRaWAN V1.0)

- For LoRaWAN V1.1,
- 1) Set the ACTIVATION parameter to ABP.
 - 2) Set DEV_ADDR to a value specific to an End Device.
 - 3) Set FNWKS_IKEY, SNWKS_IKEY, NWKS_EKEY and APPS_KEY parameters to the four session keys unique to an End Device.

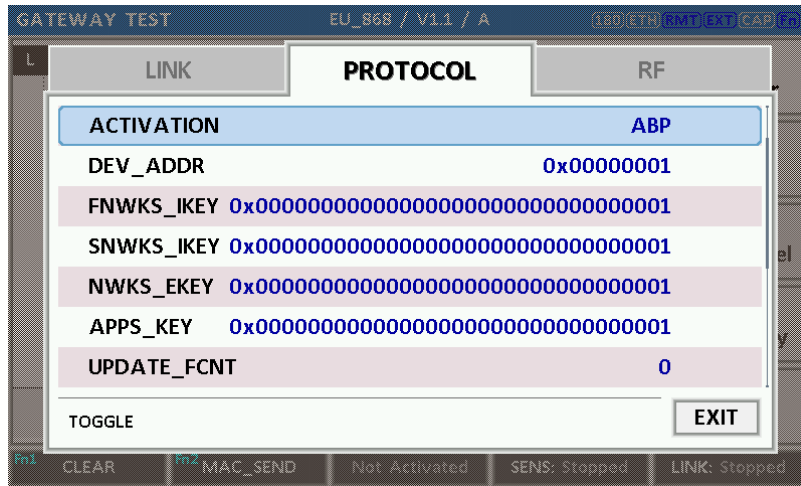

Fig 3.26 Parameters for ABP (LoRaWAN V1.1)

5. [RF Parameters Setup]

Refer to 3.10.2 for RF setup.

3.10 Usage of Link Analyzer for GWT

3.10.1 Overview

RWC5020A/B provides a function of Link Analyzer for EDT and GWT. In GWT, Link Analyzer helps to create a link between RWC5020A/B and a Gateway Under Test and to analyze the protocol messages.

3.10.2 Test Procedure

1. [Main Menu selection]

Set the Main Menu to GWT referring to 2.3.1.

2. [Sub Menu selection]

Set the Sub Menu to Link Analyzer referring to 2.3.2.

3. [Parameter configuration]

Press **PARAM** key to open the parameter configuration screen. Configure protocol parameters or RF parameters for users' purposes in PROTOCOL tab or RF tab respectively. Refer to 3.9 and 3.10 for details.

4. [DUT connection setup]

Connect the RF port of RWC5020A/B to the RF port of DUT with an RF cable for conduction test. For radiation tests, use a special test environment, e.g., a shield box or an antenna. In the latter case, it is recommended to use a test jig for DUT positioning to guarantee the reliability and repeatability of test and measurement results.

5. [Execution]

Press **RUN** key, and RWC5020A/B will send a message to the DUT. As soon as communication starts, link messages between DUT and RWC5020A/B will be displayed in real time. On the right bottom side of the screen the link status is displayed as 'LINK: Running' or 'LINK: Stopped'. Refer to 2.5.4 for descriptions of the Link Analyzer screen.

6. [Analysis and utilization]

Pressing **←** or **→** key moves the cursor location to the link message window. Rotating the rotary knob shows the raw data of the current cursor position at the bottom of the screen in hexa-decimal format. Rotating the rotary knob with **Fn** key pressed scrolls the screen by page-up or page-down. Pressing **←** or **→** key with **Fn** key pressed scrolls the screen in horizontal direction.

7. [Switch to other Sub Menu]

While the link status is running, switching to the other Sub Menu is available. All data in Link Analyzer, Power vs. Time, and Power vs. Channel are synchronized with each other, since

RWC5020A/B analyzes protocol messages and also measures RF power in processing the received frames.

3.10.3 Parameters

RWC5020A/B provides a function of sending a MAC command to DUT, defined in the LoRaWAN Specification, at the time users want. All parameters for each MAC command are configurable. Refer to 3.14 for details.

MAC_CMD_TYPE

This parameter defines the type of MAC command to be transmitted: confirmed or unconfirmed.

MAC_CMD_FIELD

This parameter defines the type of field where MAC command is stored in a frame: payload or option field.

MAC_ANS_TO

This parameter defines MAC answer time-out after sending MAC command

FOPTS_SIZE

This parameter defines the size of the FOpts field. This parameter is shown if MAC_CMD_FIELD is set as FOPTION.

FOPTS

This parameter defines the content of FOpts in hexadecimal format. This parameter is shown if MAC_CMD_FIELD is set as FOPTION.

INSTANT_MAC_CMD

This parameter defines which MAC command will be transmitted.

INSTANT_MAC_CMD: LINK_CHECK

This parameter is for sending *LinkCheckReq* command to DUT, which expects *LinkCheckAns* command from it. *LinkCheckReq* command may be used to validate connectivity with the network.

INSTANT_MAC_CMD: DEVICE_TIME

This parameter is for sending *DeviceTimeReq* command to DUT, which expects *DeviceTimeAns* command from it. *DeviceTimeReq* command requests the current network date and time from the network.

INSTANT_MAC_CMD: DEVICE_MODE

This parameter is for sending *DeviceModeInd* command to DUT, which expects *DeviceModeConf* command from it. With *DeviceModeInd* command, RWC5020A/B indicates to the network that it wants to operate either in class A or C.

INSTANT_MAC_CMD: RESET_IND

This parameter is for sending *ResetInd* command to DUT, which expects *ResetConf* command from it. With *ResetInd* command, RWC5020A/B indicates to the network that it has been re-initialized and that it has switched back to its default MAC & radio parameters (i.e. the parameters originally programmed into the device at fabrication except for the three frame counters). This MAC command is only available to ABP devices activated on a LoRaWAN1.1 compatible Network Server.

PERIODIC_UPLINK

This parameter defines the periodic uplink of RWC5020A/B after the activation procedure finishes. The type of periodic uplink can be LINK_CHECK_REQ, CONFIRMED_UP, UNCONFIRMED_UP, or DL_COUNTER.

MIN_MAC_INTERVAL

This parameter defines the minimum time interval of the periodic uplink.

FPORT

This parameter defines the FPort number of a user-defined MAC Command.

PAYLOAD_SIZE

This parameter defines the size of payload of a user-defined MAC Command.

PAYLOAD





This parameter defines the content of the payload in hexadecimal format.

3.11 Usage of Power Measure for GWT

3.11.1 Overview

RWC5020A/B provides a function of Power measurement for EDT and GWT. In GWT, RWC5020A/B has Power vs. Time and Power vs. Channel measurements which help to create a link between RWC5020A/B and a Gateway Under Test and to measure the received power with respect to data rates.

3.11.2 Test Procedure





1. [Main Menu selection]
Set the Main Menu to GWT referring to 2.3.1.
2. [Sub Menu selection]
Set the Sub Menu to Power Measure referring to 2.3.2.
3. [Parameter configuration]
Press  key to open the parameter configuration screen. Configure protocol parameters or RF parameters for users' purposes in PROTOCOL tab or RF tab respectively. Refer to 3.9 and 3.10 for details.
4. [DUT connection setup]
Connect the RF port of RWC5020A/B to the RF port of DUT with an RF cable for conduction test. For radiation tests, use a special test environment, e.g., a shield box or an antenna. In the latter case, it is recommended to use a test jig for DUT positioning to guarantee the reliability and repeatability of test and measurement results.
5. [Execution]
Press  key, and RWC5020A/B will send a message to the DUT. As soon as communication starts, the measured power will be displayed on the screen in real time. On the right bottom side of the screen the link status is displayed as 'LINK: Running' or 'LINK: Stopped'. Refer to 2.5.5 for descriptions of the Power vs. Time screen.
6. [Analysis and utilization]
In Power vs. Time mode, Pressing  or  key moves the cursor location to the measurement window, and the cursor changes to the marker. Rotating the rotary knob shows all measured values of the current marker position at the top of the screen.
7. [Switch to other Sub Menu]
While the link status is running, switching to the other Sub Menu is available. All data in Link Analyzer, Power Measure are synchronized with each other, since RWC5020A/B analyzes protocol messages and also measures RF power in processing the received frames.

3.12 Usage of Receiver Sensitivity for GWT

3.12.1 Overview

Receiver Sensitivity is a function of testing the receiver performance of DUT. RWC5020A/B sweeps its power level from the start value to the stop value with the step value and checks whether DUT functions properly, and stops immediately after DUT does not function properly.

3.12.2 Test Procedure

1. [Main Menu selection]
Set the Main Menu to GWT referring to 2.3.1.
2. [Sub Menu selection]
Set the Sub Menu to Receiver Sensitivity referring to 2.3.2.
3. [Parameter configuration]
Press  key to open the parameter configuration screen. Configure protocol parameters or RF parameters for users' purposes in PROTOCOL tab or RF tab respectively. Refer to 3.9 and 3.10 for details. In SENSITIVITY tab, all parameters can be configured to be used in the execution of sensitivity tests.
4. [DUT connection setup]
Connect the RF port of RWC5020A/B to the RF port of DUT with an RF cable for conduction test. For radiation tests, use a special test environment, e.g., a shield box or an antenna. In the latter case, it is recommended to use a test jig for DUT positioning to guarantee the reliability and repeatability of test and measurement results.
5. [Execution]
Press  key, and RWC5020A/B will send a message for activation to the DUT. As soon as the activation procedure finishes, RWC5020A/B starts the sensitivity test from the start power value, checks whether DUT functions properly at each power step value, stops immediately after DUT does not function properly, and shows the final results. On the right bottom side of the screen the sensitivity status is displayed as 'SENS: Running' or 'SENS: Stopped' as well as the link status. Refer to 2.5.7 for descriptions of the Receiver Sensitivity screen.
6. [Analysis and utilization]
Pressing  or  key moves the cursor location to the sensitivity window, and the cursor changes to the marker. Rotating the rotary knob shows all measured values of the current marker position at the top of the screen.
7. [Switch to other Sub Menu]
While the sensitivity status is running, switching to the other Sub Menu is available. All data in Link

Analyzer, Power vs. Time, and Power vs. Channel are synchronized with each other, since RWC5020A/B analyzes protocol messages and also measures RF power in processing the received frames.

3.12.3 Parameters

PACKET_NUM

This is the packet number of tests at each test point. Increasing the value increases the resolution of the test results, but may increase the test time.

START_POW

This defines the start value of POWER sweep in POWER mode.

STOP_POW

This defines the stop value for POWER sweep in POWER mode (read only).

STEP_POW

This defines the step value for POWER sweep in POWER mode.

NUM_POW

This defines the number of power values for POWER sweep.

TARGET_DR

This is a parameter to determine Uplink DR for Sensitivity Test.

TARGET_PER

This is a parameter to set the user's target PER. In POWER mode, the test sweeps fully in the range of POWER until DUT does not satisfy TARGET_PER.

3.13 Transmission of MAC Commands for GWT

3.13.1 Overview

After the activation procedure is completed successfully, RWC5020A/B can send any MAC command to DUT as defined on Parameter configuration.

3.13.2 Test Procedure

1. [Activation]

Follow the steps referring to 3.11 to complete the activation successfully.

2. [MAC command selection]

Press **PARAM** key to open the parameter configuration screen and move to LINK tab. Select a MAC command to be sent from the list of INSTANT_MAC_CMD and configure its parameters. Refer to 3.10.3 for details about MAC commands. Close the parameter configuration screen.

3. [MAC command transmission]

Press **Fn** + **2 B** key to select 'MAC_SEND' button on the bottom of the screen. Then RWC5020A/B will send the MAC command to DUT at the next uplink channel.

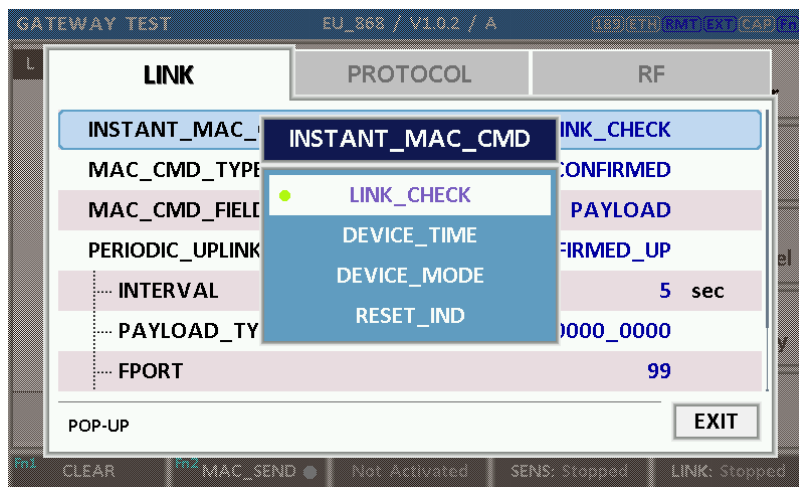

Fig 3.27 Example of MAC command selection

GATEWAY TEST											EU_868 / V1.0.2 / A		189 ETH RMT EXT CAP Fn		
L	CH	DR	SF	BW	Pow	Time	FCnt	AckPort	M	dwell	CMD	Link Analyzer			
U	1	0	12	125	-30.0	REF	----	0	---	-	1482	Join-request	<div style="border: 1px solid gray; padding: 5px; margin-bottom: 5px;">Power vs. Time</div> <div style="border: 1px solid gray; padding: 5px; margin-bottom: 5px;">Power vs. Channel</div> <div style="border: 1px solid gray; padding: 5px; margin-bottom: 5px;">Receiver Sensitivity</div>		
D	1	0	12	125	-35.9	----	----	0	---	-	1155	Join-accept			
U	2	0	12	125	-30.0	12.9s	0000	0	099	U	1646	DataUp			
D	2	0	12	125	-31.6	----	0000	0	224	U	1155	Activate_TM			
U	0	0	12	125	-30.0	5.00s	0001	0	224	U	1155	DownlinkCounte			
U	1	0	12	125	-30.0	5.21s	0002	0	000	U	1155	LinkCheckReq			
D	1	0	12	125	-31.6	----	0001	0	000	U	1155	LinkCheckAns			
U	2	0	12	125	-30.0	5.00s	0003	0	224	U	1155	DownlinkCounte			
U	2	0	12	125	-30.0	5.21s	0004	0	224	U	1155	DownlinkCounte			
U	2	0	12	125	-30.0	5.20s	0005	0	224	U	1155	DownlinkCounte			
Margin=20, GwCnt=1															
60 01 00 00 00 80 01 00 00 02 14 01 5A 19 F1 86															
Fn1 CLEAR		Fn2 MAC_SEND		Not Activated		SENS: Stopped		LINK: Stopped							

Fig 3.28 Example a single MAC command transmission (Fn + 2 B)

3.14 Usage of Link Analyzer for Class B GWT

3.14.1 Overview

This section shows how to connect Class B Gateway and configure related parameters.

3.14.2 Test Procedure

1. [Parameter Configuration]

Press **PARAM** key to open the parameter configuration screen and move to PROTOCOL tab. Select CLASS as B and configure parameters such as PING_PERIODICITY and PING_DR.

2. [Activation]

Refer to 3.10 to configure parameters for activation.

3. [Execution]

Press **RUN** key, and RWC5020A/B will be starting activation. As soon as the activation procedure finishes, RWC5020A/B sends the DeviceTimeReq command to DUT. The following figure is an example of communication between Class B Gateway and RWC5020A/B, showing related MAC commands and Class B flag.

4. [MAC command transmission]

Refer to 3.16 for details of MAC command transmission, which is also applicable to Class B.

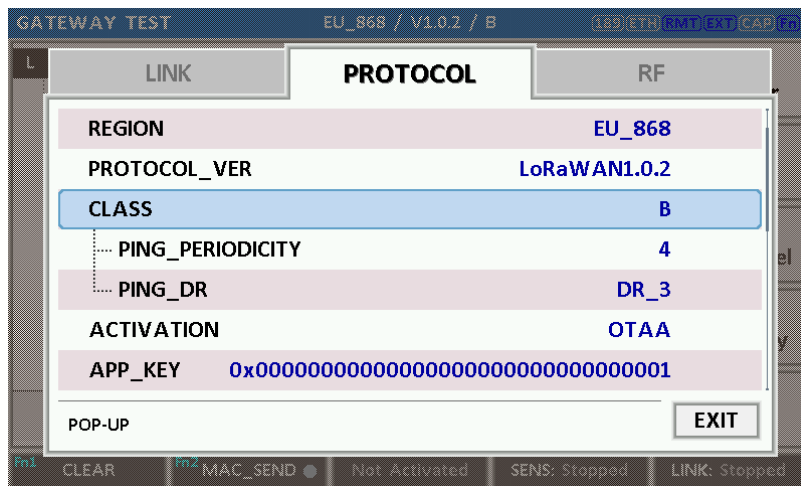

Fig 3.29 Selection of Class B in Parameter Configuration



Fig 3.30 Example of communication with Class B Gateway

3.15 Malfunction Test for EDT / GWT

3.15.1 Overview

After the activation procedure is completed successfully, RWC5020A/B can send MAC commands that have intentionally inserted an error.

3.15.2 Test Procedure

1. [Activation]

Follow the steps referring to 3.3 to complete the activation successfully.

2. [MAC command selection]

Press **PARAM** key to open the parameter configuration screen and move to LINK tab. Select a MAC command to be sent from the list of INSTANT_MAC_CMD and configure its parameters. Refer to 3.6 for details about MAC commands.

3. [Malfunction Editing]

Set the MALFUNCTION parameter to ON for failure testing. To generate an intentional MIC error, set MIC_ERROR to ON. To modify the MAC header part, set MHDR_ERROR to ON and configure the XOR_MHDR value. XOR_MHDR value is exclusive OR with MAC Header. To modify the Frame header part, set FHDR_ERROR to ON and configure the XOR_FHDR value. XOR_FHDR value is exclusive OR with Frame Header.

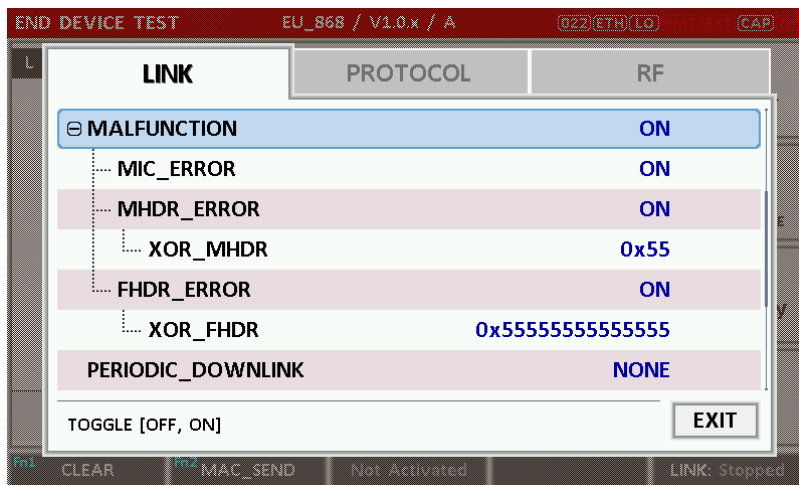

Fig 3.31 Malfunction configuration parameters

4. [MAC command transmission]

Press **Fn** + **2 B** key to select 'MAC_SEND' button on the bottom of the screen. Then RWC5020A/B will send intentionally modified MAC commands to the DUT.

5. This function is also applied to GWT.

3.16 Usage of Signal Generator for NST

3.16.1 Overview

Signal Generator is a function of transmitting the defined test waveform to DUT repeatedly. Three different modulations are provided; LoRa, FSK and CW.

3.16.2 Test Procedure

1. [Main Menu selection]
Set the Main Menu to NST referring to 2.3.1.
2. [Sub Menu selection]
Set the Sub Menu to Signal Generator referring to 2.3.2.
3. [Parameter configuration]
Press **PARAM** key to open the parameter configuration screen. Configure parameters for users' purposes in NST_TX tab.
4. [DUT connection setup]
Connect the RF port of RWC5020A/B to the RF port of DUT with an RF cable for conduction test. For radiation tests, use a special test environment, e.g., a shield box or an antenna. In the latter case, it is recommended to use a test jig for DUT positioning to guarantee the reliability and repeatability of test and measurement results.
5. [Execution]
Press **RUN** key, and RWC5020A/B will start transmission of a test waveform to the DUT. If REPEAT_NUM is set to zero, the test waveform will be transmitted infinitely. Otherwise, RWC5020A/B will stop automatically right after the number of transmission reaches the REPEAT_NUM value.

3.16.3 NST_TX Parameters

MODULATION

This parameter defines the modulation type of Signal Generator; LoRa, FSK or CW.

NETWORK

This parameter indicates the type of LoRa network (synchronization word) to be used in LoRa modulation.

BW

This parameter defines the bandwidth of a LoRa test frame.

SF

This parameter defines the spreading factor of a LoRa test frame.

CR

This parameter defines the coding rate of a LoRa test frame'.

PREAMBLE_SIZE

This parameter defines the preamble size of a LoRa test frame.

PAYLOAD_SIZE

This parameter defines the size of the payload of the LoRa test frame.

PAYLOAD

This parameter defines the content of the payload in hexadecimal format.

FM_DEVIATION

This parameter defines the FM deviation value for FSK modulation.

DATA_RATE

This parameter defines the data rate value for FSK modulation.

SYNC_WORD_SIZE

This parameter defines the Sync word size for FSK modulation

SYNC_WORD

This parameter defines the Sync word for FSK modulation

TX_POLARITY

This parameter defines the TX signal polarity.

REPEAT_NUM

This parameter defines the number of transmissions of a LoRa test frame.

INTERVAL

This parameter defines the time interval between consecutive LoRa test frames.

3.16.4 RF Parameters

TX_POW

This parameter defines the output power of RWC5020A/B in dBm.

PATH_LOSS

Users can set the path loss between the RF port of RWC5020A/B and DUT RF port. RWC5020A/B's real output power will be increased by this value to compensate for path loss.

FREQ

This parameter defines the frequency of RWC5020A/B.

SYSCLK_OFFSET

This parameter defines the system clock frequency (32MHz) offset value in ppm. It modifies RF frequency as well as LoRa modulation signal.

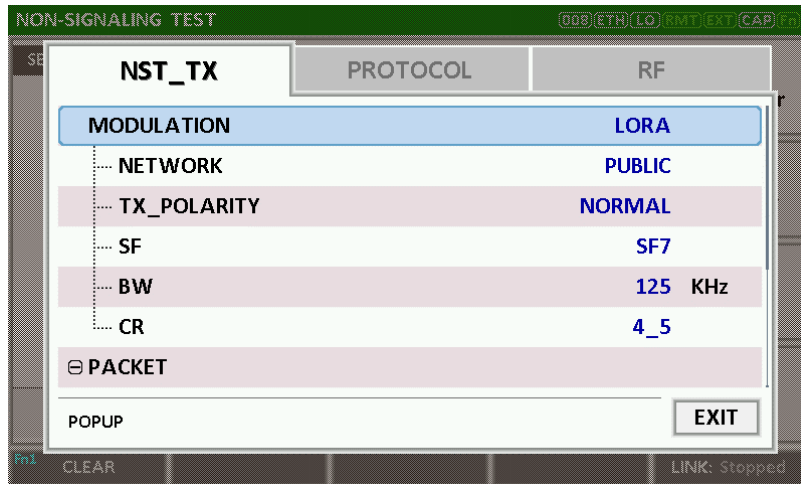

Fig 3.31 NST_TX Parameters for Signal Generator



Fig 3.32 RF Parameters for Signal Generator

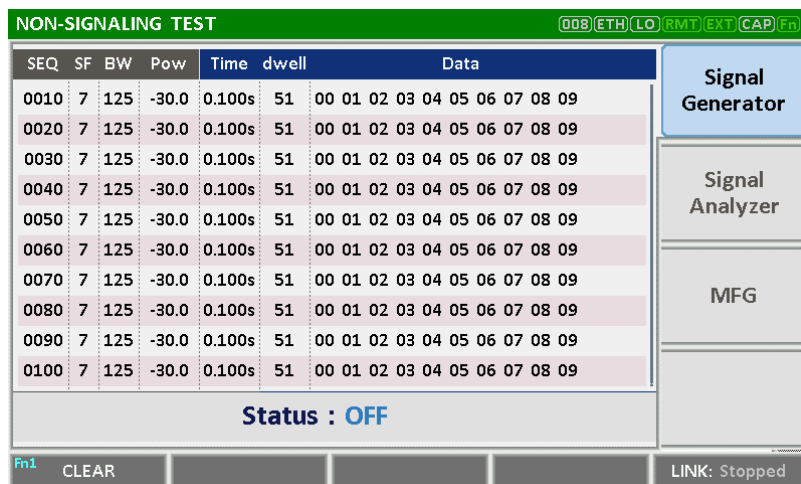

Fig 3.33 Signal Generator screen

3.17 Usage of Signal Analyzer for NST

3.17.1 Overview

Signal Analyzer is a function of analyzing LoRa frames received from DUT repeatedly.

3.17.2 Test Procedure

1. [Main Menu selection]
Set the Main Menu to NST referring to 2.3.1.
2. [Sub Menu selection]
Set the Sub Menu to Signal Analyzer referring to 2.3.2.
3. [Parameter configuration]
Press **PARAM** key to open the parameter configuration screen. Configure parameters for users' purposes in NST_RX tab.
4. [DUT connection setup]
Connect the RF port of RWC5020A/B to the RF port of DUT with an RF cable for conduction test. For radiation tests, use a special test environment, e.g., a shield box or an antenna. In the latter case, it is recommended to use a test jig for DUT positioning to guarantee the reliability and repeatability of test and measurement results.
5. [Execution]
Press **RUN** key, and RWC5020A/B will start measurement of a test waveform from the DUT. RWC5020A/B will not only measure TX power of DUT but also count the number of received frames only when all parameters are matched with those of the received frames, e.g. Spreading Factor. RWC5020B measures CW frequency when the MODULATION is set as CW.

3.17.3 NST_RX Parameters

MODULATION

This parameter defines the modulation type of Signal Analyzer; LoRa, FSK or CW.

NETWORK

This parameter indicates the type of LoRa network (synchronization word) to be used in LoRa modulation.

BW

This parameter defines the bandwidth of a LoRa test frame to receive.

SF

This parameter defines the spreading factor of a LoRa test frame to receive. If this value is set as ANY, RWC5020A/B receives any kind of SF packets

DATA_RATE

This parameter defines the data rate value for FSK modulation.

SYNC_WORD_SIZE

This parameter defines the Sync word size for FSK modulation

SYNC_WORD

This parameter defines the Sync word for FSK modulation

RX_POLARITY

This parameter defines the RX signal polarity.

3.17.4 RF Parameters

PATH_LOSS

Users can set the path loss between the RF port of RWC5020A/B and DUT RF port. The measured power will be compensated with the defined path loss.

FREQ

This parameter defines the frequency of RWC5020A/B.

RX_AGC

This parameter determines whether RX Gain is automatically adjusted or not.

RX_GAIN

RWC5020A/B has an Automatic Gain Control (AGC) function for the receiver. If RX_AGC is ON, RX

gain automatically adjusts to the appropriate value according to the output power of the DUT. Setting RX_GAIN to match the output power of the DUT can make AGC work very fast. When RX_AGC is OFF, set RX_GAIN to match the output power of the DUT. It is useful for manufacturing tests for fast and reliable testing with the DUT's estimated TX power.

RX GAIN WARNING TO

If RWC502x does not receive RX packets for a while, RWC502x assumes that RX_GAIN may be incorrect and displays a notification. This parameter defines the timeout period for this notification.

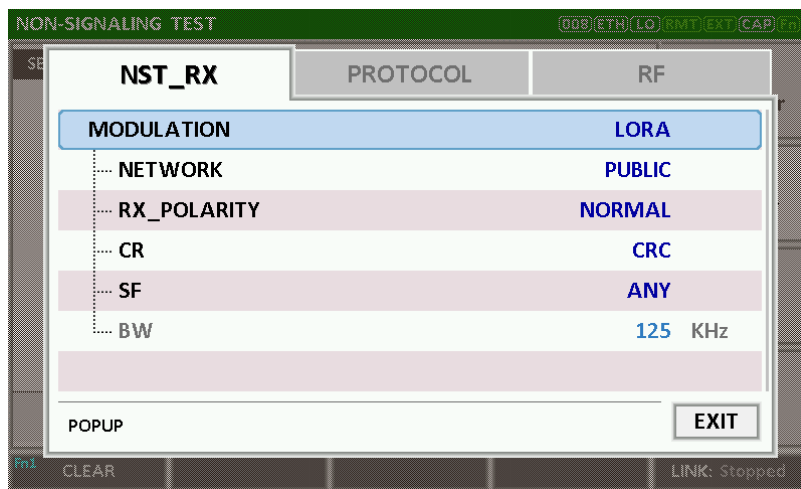

Fig 3.36 NST_RX Parameters for Signal Analyzer



Fig 3.38 RF Parameters for Signal Analyzer

NON-SIGNALING TEST										18D ETH RMT EXT CAP Fn						
SEQ	SF	BW	Pow	Time	FCnt	Port	Data				Signal Generator					
51	7	125	-31.0	7.35s	003C	99	40	01	00	00	00	3C	00	63	00	Signal Analyzer
52	7	125	-31.0	0.25s	003D	99	40	01	00	00	00	3D	00	63	00	MFG Measure
53	7	125	-31.0	0.23s	003E	99	40	01	00	00	00	3E	00	63	00	
54	7	125	-30.9	0.24s	003F	99	40	01	00	00	00	3F	00	63	00	
55	7	125	-31.0	0.23s	0040	99	40	01	00	00	00	40	00	63	00	
56	7	125	-31.0	0.24s	0041	99	40	01	00	00	00	41	00	63	00	
57	7	125	-30.9	0.23s	0042	99	40	01	00	00	00	42	00	63	00	
58	7	125	-31.0	0.23s	0043	99	40	01	00	00	00	43	00	63	00	
59	7	125	-31.0	0.24s	0044	99	40	01	00	00	00	44	00	63	00	
60	7	125	-30.9	0.23s	0045	99	40	01	00	00	00	45	00	63	00	
			MAX: -30.9dBm		AVG: -31.1dBm		MIN: -31.3dBm									
Fn1 CLEAR										LINK: Running						

Fig 3.39 Signal Analyzer screen

3.18 Usage of MFG for NST

3.18.1 Overview

MFG is a function of testing TX and RX performances of DUT automatically in manufacturing lines. Various parameters are configurable as users' purposes.

3.18.2 Test Procedure

1. [Main Menu selection]
Set the Main Menu to NST referring to 2.3.1.
2. [Sub Menu selection]
Set the Sub Menu to MFG referring to 2.3.2.
3. [Parameter configuration]
Press **PARAM** key to open the parameter configuration screen. Configure parameters for users' purposes in NST_MFG tab.
4. [DUT connection setup]
Connect the RF port of RWC5020A/B to the RF port of DUT with an RF cable for conduction test. For radiation tests, use a special test environment, e.g., a shield box or an antenna. In the latter case, it is recommended to use a test jig for DUT positioning to guarantee the reliability and repeatability of test and measurement results.
5. [Execution]
Press **RUN** key, and RWC5020A/B will wait until receiving a trigger signal from DUT, then start transmission of the test frame as many as a pre-defined number of times. If done, the tester will wait until receiving the test report from DUT, which will include the number of frames it received successfully. RWC5020A/B will not only calculate PER but also measure TX power of DUT.

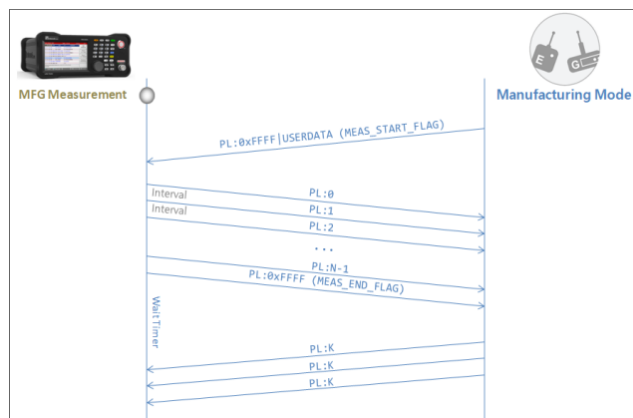

Fig 3.40 Test Scenario in MFG Test

3.18.3 NST_MFG Parameters

MODULATION

This parameter defines the modulation type of the MFG test; LoRa, FSK or CW.

NETWORK

This parameter indicates the type of LoRa network (synchronization word) to be used in LoRa modulation in the MFG test.

BW

This parameter defines the bandwidth of a LoRa test frame to be used in the MFG test.

SF

This parameter defines the spreading factor of a LoRa test frame to be used in the MFG test. If this value is set as ANY, RWC5020A/B receives any kind of SF packet and applies this SF value for TX packets.

CR

This parameter defines the coding rate of a LoRa test frame to be used in the MFG test, which is applicable only when DUT_TYPE is 'GATEWAY'.

PREAMBLE_SIZE

This parameter defines the preamble size of a LoRa test frame to be used in the MFG test.

PAYLOAD_SIZE

This parameter defines the size of the payload of the LoRa test frame in the MFG test.

PAYLOAD

This parameter defines the content of payload in hexadecimal format in the MFG test.

FM_DEVIATION

This parameter defines the FM deviation value for FSK modulation.

DATA_RATE

This parameter defines the data rate value for FSK modulation.

SYNC_WORD_SIZE

This parameter defines the Sync word size for FSK modulation

SYNC_WORD

This parameter defines the Sync word for FSK modulation

TX_POLARITY

This parameter defines the TX signal polarity.

RX_POLARITY

This parameter defines the RX signal polarity.

REPEAT_NUM

This parameter defines the number of transmissions of a LoRa test frame to be used in the MFG test.

INTERVAL

This parameter defines the time interval between consecutive LoRa test frames to be used in MFG test.

PER_CRITERIA

This parameter defines the user's criteria of the result value of PER measurement in the MFG test.

POW_CRITERIA_UPPER

This parameter defines the user's upper criteria of the result value of Power measurement in the MFG test.

POW_CRITERIA_LOWER

This parameter defines the user's lower criteria of the result value of Power measurement in the MFG test.

TIME_OUT

This parameter defines the timeout until RWC5020A/B waits for a LoRa frame from DUT.

3.18.4 RF Parameters

TX_POW

This parameter defines the output power of RWC5020A/B in dBm.

PATH_LOSS

Users can set the path loss between the RF port of RWC5020A/B and DUT RF port. The measured power will be compensated with the defined path loss.

FREQ

This parameter defines the frequency of RWC5020A/B.

RX_AGC

This parameter determines whether RX Gain is automatically adjusted or not

RX_GAIN

RWC5020A/B has an Automatic Gain Control (AGC) function for the receiver. If RX_AGC is ON, RX gain automatically adjusts to the appropriate value according to the output power of the DUT. Setting RX_GAIN to match the output power of the DUT can make AGC work very fast. When RX_AGC is OFF, set RX_GAIN to match the output power of the DUT. It is useful for manufacturing tests for fast and reliable testing with the DUT's estimated TX power.

RX_GAIN_WARNING_TO

If RWC502x does not receive RX packets for a while, RWC502x assumes that RX_GAIN may be incorrect and displays a notification. This parameter defines the timeout period for this notification.

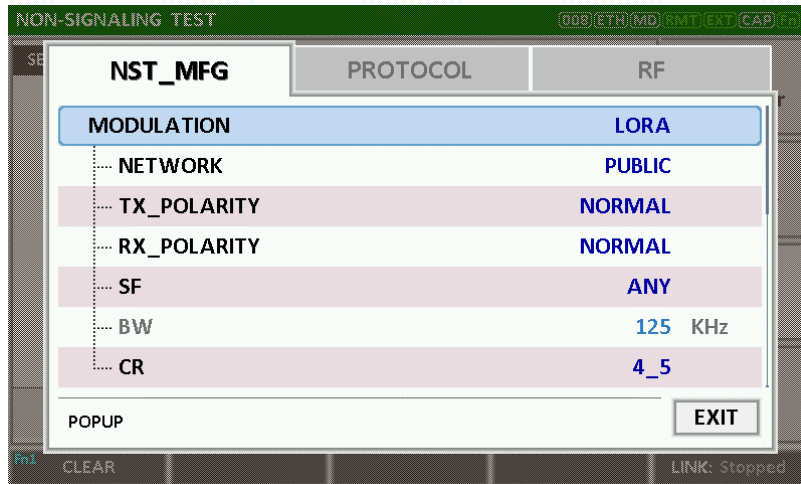

Fig 3.41 NST_MFG Parameters for MFG Test (1/2)

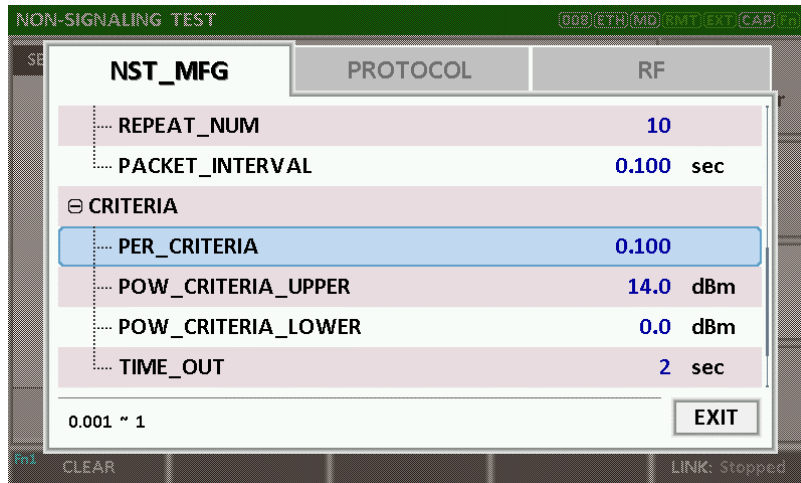

Fig 3.42 NST_MFG Parameters for MFG Test (2/2)



Fig 3.44 RF Parameters for MFG Test

NON-SIGNALING TEST										18D ETH RMT EXT CAP Fn									
SEQ	SF	BW	Pow	Time	FCnt	Port	Data												
94	7	125	-50.0	0.10s	----	---	5E 00 02 03 04 05 06 07 08 09												
95	7	125	-50.0	0.10s	----	---	5F 00 02 03 04 05 06 07 08 09												
96	7	125	-50.0	0.10s	----	---	60 00 02 03 04 05 06 07 08 09												
97	7	125	-50.0	0.10s	----	---	61 00 02 03 04 05 06 07 08 09												
98	7	125	-50.0	0.10s	----	---	62 00 02 03 04 05 06 07 08 09												
99	7	125	-50.0	0.10s	----	---	63 00 02 03 04 05 06 07 08 09												
100	7	125	-50.0	0.10s	----	---	FF FF 02 03 04 05 06 07 08 09												
1	7	125	9.3	23.33s	----	---	FF FF 00 64												
2	7	125	9.0	0.19s	----	---	FF FF 00 64												
3	7	125	9.0	0.21s	----	---	FF FF 00 64												
PER: 0.000 (0/100) POW: 9.1dBm																			
Fn1 CLEAR										LINK: Running									

Fig 3.45 Example of MFG Test Completion

IV. Remote Control Programming

A PC may control the RWC5020x/5021x remotely through Ethernet or RS232C interface using a comprehensive set of commands. This section provides the necessary information to operate the RWC5020x/5021x under Ethernet and RS232C control.

- 4.1 Introduction
- 4.2 RS-232C Interface
- 4.3 Ethernet Interface
- 4.4 Command List

4.1 Introduction

The RWC5020x/5021x supports RS232C (VCOM for RWC5021P) and Ethernet Interface, located at the rear panel for remote operation under PC control. Ethernet is used for high speed and flexible interfaces. To use Ethernet, socket programming is required. RS232C is a slow serial interface, but it does not need any special devices, and is easy to use.

4.1.1 Command Structure

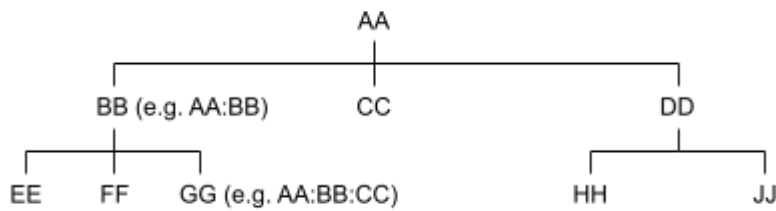

Fig 4.1 Command Structure

- You must follow a particular path to reach lower level subcommands. For example, if you wish to access the GG command, you must follow the path AA to BB to GG (AA:BB:GG)
- Commands consist of *set commands* and *query commands* (usually simply called commands and queries). Set commands change instrument settings or perform a specific action. Queries cause the RWC5020x/5021x to return data and information about its status. Most commands have both a set form and query form. The query form of the command is started with “READ” and the set form of the command is started with “CONF”.
- For example, one of the set commands is **CONF:RF:TX_POW -100.0** and one of the query commands is **READ:RF:TX_POW?**
- When a *colon* is placed between two command mnemonics, it moves the current path down one level in the command tree
- A *space* is used to separate parameters from commands. AA:BB:FF 20
- Some commands require two parameters. Refer to Command list.

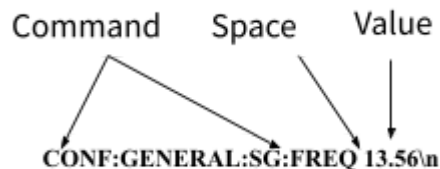

Fig 4.2 Set Command

NOTE: All commands should be finished by LF (Line Feed, Char(10)) or semicolon(;).

4.1.2 Command Parameter Types

- Integer Parameter: CONF:RF:TX_POW <Value> <LF>
- Discrete Parameter: CONF:SYSTEM:REF_CLK {INT | EXT} <LF>

4.1.3 Response to Query

- Integer: Returns an integer value, e.g., 0, 100, 256, -230.
- Discrete: Returns selection

Command & Query	Response
READ:RF:TX_POW?	-100.0
READ:SYSTEM:REF_CLK?	EXT

NOTE: All responses are finished by LF (Line Feed, Char(10)).

4.2 RS-232C Interface

4.2.1 Configuration

RS-232C Connection

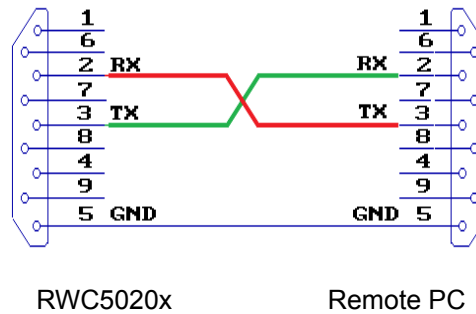

Fig 4.3 RS-232C Connection

RS-232C Parameter Setup

RS-232C parameters of Remote PC should be set up as the following:

Parameter	Value	Description
DATA_RATE	115200	BPS
DATA BITS	8-bit	Length of Data Bit
PARITY	Off	Error Check Bit
STOP BIT	1-bit	Stop bit

4.2.2 Remote Programming Guide Using RS-232C on a Windows System

Programming Sequence

- Set Serial Port
- Set up Baud Rate, Parity Bit (None), Data Bit (8 bit), Stop Bit (1 bit).
- Open port.
- Send RS-232C command through serial port.
- Check command execution results on the RWC5020x/5021x screen.
- Send the next command after successful execution of the previous command.

If it is difficult to check the execution of the previous command, the next command should be sent after a few milliseconds.

Tips for Programming

- A colon is used between commands.
- A space is only used between parameter values and commands.
- All commands should be finished by LF (Line Feed, Char(10)).

4.3 Ethernet Interface

4.3.1 PC Configuration

Connect LAN port of PC and RWC5020A/B Ethernet port by RJ45 cable. If the PC and RWC5020A/B are connected directly, crossover cable must be used. Then set up the IP address as follows

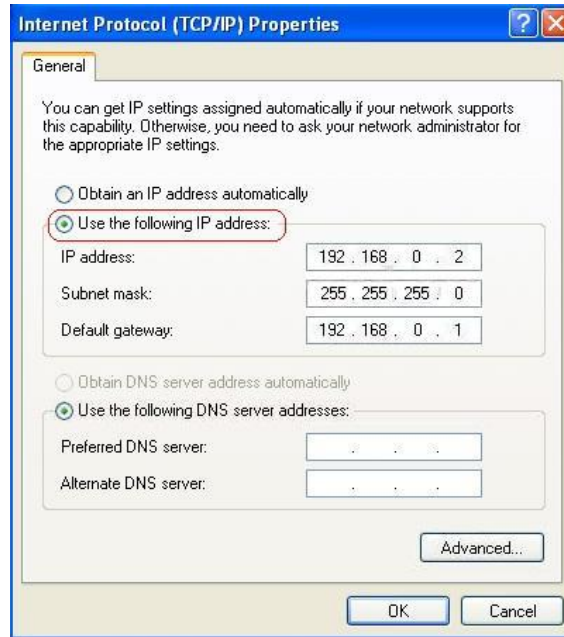

Fig 4.4 IP Configuration

4.3.2 RWC5020A/B Configuration

Turn RWC5020A/B power ON, and press **SYSTEM** key to move to the system configuration screen and configure IP address referring to 2.6.



Fig 4.5 RWC5020A/B IP Configuration

4.3.3 RWC5020M Configuration

Refer to A.4 and A.5

4.3.4 RWC5021P Configuration

Refer to B.4

4.3.5 UDP Port number

RWC502x supports only the UDP protocol, and the UDP port number is fixed at 5001.

4.4 Command List

4.4.1 Common Commands

Command	Parameter Range	Description	Model
*IDN?	N/A	Query Identification	All
*RST	N/A	Preset the equipment fully	All
*SAVE	SAVE_0 ~ SAVE_9	Save the current parameters setting to memory	All
*RECALL	SAVE_0 ~ SAVE_9	Recall the saved parameters setting from memory	All
*REBOOT	N/A	Reboot the tester	All
*FACTORY_RST	N/A	Factory Reset	All

4.4.2 Basic Commands

Command	Parameter Range	Description	Model
CONF:TESTER_MODE	EDT GWT NST_TX NST_RX NST_MFG	Configure/Read an operating mode (or Main Menu) of RWC5020A/B/M. RWC5021P supports only EDT	All
READ:TESTER_MODE?	Query only		
CONF:REMOTE:LOCK	OFF ON	Lock or Unlock the key input during Remote Control	All
READ:REMOTE:LOCK?	Query only		
CONF:MOVE_SCREEN	LINK POWER_TIME POWER_CHANNEL SENSITIVITY	Configure a screen (or Sub Menu) of RWC5020A/B to move directly to	A/B

4.4.3 Commands for RF Parameters

Command	Parameter Range	Description	Model
CONF:RF:FREQ	400~510, 862~960	Configure/Read TX CW frequency in MHz for Non-signaling test	All
READ:RF:FREQ?	Query only		
CONF:RF:TX_FREQ	400~510, 862~960	Configure/Read TX CW frequency in MHz for Non-signaling test	A/B/M
READ:RF:TX_FREQ?	Query only		
CONF:RF:RX_FREQ	400~510, 862~960	Configure/Read RX CW frequency in MHz for Non-signaling test	A/B/M
READ:RF:RX_FREQ?	Query only		
CONF:RF:MFG_FREQ	400~510, 862~960	Configure/Read frequency in MHz for MFG test	A/B/M
READ:RF:MFG_FREQ?	Query only		
CONF:RF:TX_POW	-10 ~ -150 for A 0 ~ -150 for B/M 0 ~ -30 for P	Configure/Read TX POWER in dBm	All
READ:RF:TX_POW?	Query only		
CONF:RF:PATH_LOSS	0 ~ 50	Configure/Read Path Loss in dB	All
READ:RF:PATH_LOSS?	Query only		
CONF:RF:SYSCLK_OFFSET	-100 ~ 100	Configure/Read the system clock offset in ppm	B/M
READ:RF:SYSCLK_OFFSET?	Query only		
CONF:RF:FREQ_OFFSET	-1000 ~ 1000	Configure/Read the frequency offset in ppm	All
READ:RF:FREQ_OFFSET?	Query only		
CONF:RF:TIME_OFFSET	-1000 ~ 1000	Configure/Read the time offset in us	All
READ:RF:TIME_OFFSET?	Query only		
CONF:RF:CH_MASK_0	For EDT, 0x00 ~ 0xFF(EU433, KR920, AS923, RU864) 0x00 ~ 0x7F(EU868,) 0x00 ~ 0x3F(IN865) For GWT, 0x00 ~ 0xFFFF(US/AU/CN) read-only (others)	Configure/Read the channel mask of channel index 0 in both EDT and GWT mode	All
READ:RF:CH_MASK_0?	Query only		

CONF:RF:CH_MASK_1	0x00 ~ 0xFFFF	Configure/Read the channel mask of channel index 1 (only applicable to US/AU/CN in GWT mode)	All
READ:RF:CH_MASK_1?	Query only		
CONF:RF:CH_MASK_2	0x00 ~ 0xFFFF	Configure/Read the channel mask of channel index 2 (only applicable to US/AU/CN in GWT mode)	All
READ:RF:CH_MASK_2?	Query only		
CONF:RF:CH_MASK_3	0x00 ~ 0xFFFF	Configure/Read the channel mask of channel index 3 (only applicable to US/AU/CN in GWT mode)	All
READ:RF:CH_MASK_3?	Query only		
CONF:RF:CH_MASK_4	0x00 ~ 0xFF (US/AU) 0x00 ~ 0xFFFF (CN)	Configure/Read the channel mask of channel index 4 (only applicable to US/AU/CN in GWT mode)	All
READ:RF:CH_MASK_4?	Query only		
CONF:RF:CH_MASK_5	0x00 ~ 0xFFFF	Configure/Read the channel mask of channel index 5 (only applicable to CN in GWT mode)	All
READ:RF:CH_MASK_5?	Query only		
CONF:RF:CH_GROUP	For US/AU, 00~07,64 08~15,65 16~23,55, ... 56~63,71 For CN, 00~07 08~15, 16~23, ... 88~95	Configure/Read the channel group (only applicable to US/AU/CN in EDT mode)	All
READ:RF:CH_GROUP?	Query only		
CONF:RF:UL_CH	400~510, 862~960	Write Uplink Channel n frequency in MHz; For EDT, editable for param=3 (EU868) param=4 (EU433, KR, AS) other channels are fixed	All
READ:RF:UL_CH?	Query only	For GWT all channels frequencies are editable Read Uplink Channel n frequency in MHz param=0,1,...,71 (US/AU) param=0,1,...,95 (CN) param=0,1,...,7 (others)	All

READ:RF:DL_CH?	Query only	Read Downlink Channel frequency in MHz param=0,1,...,47 (CN) param=0,1,...,7 (others)	All
CONF:RF:PING_FREQ	400~510, 862~960	Configure/Read the frequency of ping channel	All
READ:RF:PING_FREQ?	Query only		
CONF:RF:PING_DR		Configure/Read the data rate of ping channel	All
READ:RF:PING_DR?	Query only		
CONF:RF:BEACON_FREQ	400~510, 862~960	Configure/Read the frequency of beacon	All
READ:RF:BEACON_FREQ?	Query only		
CONF:RF:BEACON_DR		Configure/Read the data rate of beacon	All
READ:RF:BEACON_DR?	Query only		
CONF:RF:ICA_CH_MODE	INTER_FREQ, SAME_FREQ	Configure/Read the channel mode (only applicable to CN in ICA mode)	All
READ:RF:ICA_CH_MODE?	Query only		
CONF:RF:AS923_CH_GROUP	AS_923-1, AS_923-2, AS_923-3	Configure/Read the channel group (only applicable to AS923 region)	All
READ:RF:AS923_CH_GROUP?	Query only		
CONF:RF:AS923_FREQ_OFFSET	-100 ~ 100	Configure/Read the frequency offset for channel group (only applicable to AS923 region)	All
READ:RF:AS923_FREQ_OFFSET?	Query only		
CONF:RF:GWT_CH_PLAN	8-CH, 64-CH_A	Configure/Read the channel plan (only applicable to US915, AU915 region)	B/M
READ:RF:GWT_CH_PLAN	Query only		
CONF:RF:CN470_CH_PLAN	20M_A, 20M_B, 26M_A, 26M_B	Configure/Read the channel plan (only applicable to CN470 region)	All
READ:RF:CN470_CH_PLAN?	Query only		
READ:RF:MEASURED_FREQ?	Query only	Read currently Measured CW frequency value.	B/M
READ:RF:MEASURED_FREQ_MAX?	Query only	Read Maximum value of Measured CW frequency value.	B/M
READ:RF:MEASURED_FREQ_AVG?	Query only	Read Average value of Measured CW frequency value.	B/M
READ:RF:MEASURED_FREQ_MIN?	Query only	Read Minimum value of Measured CW frequency value.	B/M
CONF:RF:RX_GAIN	HIGH, MEDIUM, LOW, LOWER	Configure/Read the RX Gain of tester (LOWER	A/B/M

READ:RF:RX_GAIN?	Query only	is only for RWC5020B/M)	
CONF:RF:RX_AGC	OFF, ON	Configure/Read the RX AGC of tester (It is only for NST RX)	A/B/M
READ:RF:RX_AGC?	Query only		

4.4.4 Commands for PROTOCOL Parameters

Command	Parameter Range	Description	Model
CONF:PROTOCOL:REGION	EU_868 EU_433 US_915 AU_915 CN_470 KR_920 AS_923 IN_865 RU_864	Configure/Read an operating Region of Tester	All
READ:PROTOCOL:REGION?	Query only		
CONF:PROTOCOL:OPERATOR	LoRaWAN, SKT for KR920 LoRaWAN, ICA for CN470	Configure/Read the LoRa service operator	All
READ:PROTOCOL:OPERATOR?	Query only		
CONF:PROTOCOL:CLASS	A B C	Configure/Read the class of LoRa device	All
READ:PROTOCOL:CLASS?	Query only		
CONF:PROTOCOL:ACTIVATION	OTAA ABP	Configure/Read the activation procedure	All
READ:PROTOCOL:ACTIVATION?	Query only		
CONF:PROTOCOL:SET_TEST_MODE	OFF ON	Configure/Read the flag whether to send the <i>ActivateTestMode</i> command after activation	All
READ:PROTOCOL:SET_TEST_MODE?	Query only		
CONF:PROTOCOL:BEACON_TIME_OFFSET	-1000 ~ 1000 ms	Configure/Read the beacon time offset.	All
READ:PROTOCOL:BEACON_TIME_OFFSET?	Query only		
CONF:PROTOCOL:APP_KEY	128-bit HEX value	Configure/Read Application Key	All
READ:PROTOCOL:APP_KEY?	Query only		

READ:PROTOCOL:REAL_KEY?	Query only	Read the Real Application Key	All
CONF:PROTOCOL:APPS_KEY	128-bit HEX value	Configure/Read Application Session Key	All
READ:PROTOCOL:APPS_KEY?	Query only		
CONF:PROTOCOL:NWKS_KEY	128-bit HEX value	Configure/Read Network Session Key	All
READ:PROTOCOL:NWKS_KEY?	Query only		
CONF:PROTOCOL:CHECK_EUI	NO YES	Configure/Read a flag whether to check DUT's EUI value for activation	All
READ:PROTOCOL:CHECK_EUI?	Query only		
CONF:PROTOCOL:DEV_EUI	64-bit HEX value	Configure/Read Device EUI value	All
READ:PROTOCOL:DEV_EUI?	Query only		
CONF:PROTOCOL:APP_EUI	64-bit HEX value	Configure/Read Application EUI value	All
READ:PROTOCOL:APP_EUI?	Query only		
CONF:PROTOCOL:DEV_ADDR	0 ~ 0xFFFFFFFF	Configure/Read Device Address value	All
READ:PROTOCOL:DEV_ADDR?	Query only		
CONF:PROTOCOL:NET_ID	0 ~ 0x7F	Configure/Read NET ID value	All
READ:PROTOCOL:NET_ID?	Query only		
CONF:PROTOCOL:RECEIVE_DELAY	1 ~ 10	Configure/Read RECEIVE_DELAY value in sec	All
READ:PROTOCOL:RECEIVE_DELAY?	Query only		
CONF:PROTOCOL:PERIODIC_UPLINK	NONE LINK_CHECK_REQ CONFIRMED_UP UNCONFIRMED_UP DL_COUNTER	Configure/Read the Periodic Uplink message in GWT	All
READ:PROTOCOL:PERIODIC_UPLINK?	Query only		
CONF:PROTOCOL:INTERVAL	3 ~ 60	Configure/Read the interval in sec between Uplink message defined by Periodic Uplink	All
READ:PROTOCOL:INTERVAL?	Query only		
CONF:PROTOCOL:UPDATE_FCNT	0 ~ 65535	Configure/Read an frame count value	All
READ:PROTOCOL:UPDATE_FCNT?	Query only		
CONF:PROTOCOL:ADR	OFF ON	Configure/Read a flag of ADR support	All

READ:PROTOCOL:ADR?	Query only		
CONF:PROTOCOL:YEAR	2000 ~ 2100	Configure/Read the year value for TIME	All
READ:PROTOCOL:YEAR?	Query only	information	
CONF:PROTOCOL:MONTH	1 ~ 12	Configure/Read the month value for TIME	All
READ:PROTOCOL:MONTH?	Query only	information	
CONF:PROTOCOL:DAY	1 ~ 31	Configure/Read the day value for TIME	All
READ:PROTOCOL:DAY?	Query only	information	
CONF:PROTOCOL:HOURL	1 ~ 23	Configure/Read the hour value for TIME	All
READ:PROTOCOL:HOURL?	Query only	information	
CONF:PROTOCOL:MINUTE	0 ~ 59	Configure/Read the minute value for TIME	All
READ:PROTOCOL:MINUTE?	Query only	information	
CONF:PROTOCOL:SECOND	0 ~ 59	Configure/Read the second value for TIME	All
READ:PROTOCOL:SECOND?	Query only	information	
CONF:PROTOCOL:LINK_MARGIN	0 ~ 254	Configure/Read the link margin value in dB for	All
READ:PROTOCOL:LINK_MARGIN?	Query only	<i>LinkCheckAns</i>	
CONF:PROTOCOL:GATEWAY_CNT	0 ~ 255	Configure/Read the gateway count value for	All
READ:PROTOCOL:GATEWAY_CNT?	Query only	<i>LinkCheckAns</i>	
CONF:PROTOCOL:BATTERY	0 ~ 255	Configure/Read the battery status value for	All
READ:PROTOCOL:BATTERY?	Query only	<i>DevStatusAns</i>	
CONF:PROTOCOL:SNR_MARGIN	-32 ~ 31	Configure/Read the SNR margin value in dB for	All
READ:PROTOCOL:SNR_MARGIN?	Query only	<i>DevStatusAns</i>	
READ:PROTOCOL:ACTIVATION_STATUS?	Query only	Read the status of activation procedure	All
CONF:PROTOCOL:NETWORK	PRIVATE PUBLIC	Configure/Read the Sync word in LoRa modulation:	All
READ:PROTOCOL:NETWORK?	Query only	0x12 for private network 0x34 for public network	

CONF:PROTOCOL:DOWNLINK_SLOT	For EDT, RX1 RX2 PING (Class B)	Configure/Read the selection of downlink slot (RX window)	All
READ:PROTOCOL:DOWNLINK_SLOT?	Query only		
CONF:PROTOCOL:MAC_RSP_FIELD	PAYLOAD FOPTS	Configure/Read the selection of MAC response field	All
READ:PROTOCOL:MAC_RSP_FIELD?	Query only		
CONF:PROTOCOL:UPLINK_DR	DR0_SF12BW125 DR1_SF11BW125 DR2_SF10BW125 ...	Configure/Read Data Rate of Uplink in GWT mode	All
READ:PROTOCOL:UPLINK_DR?	Query only		
CONF:PROTOCOL:RX1_DR_OFFSET	0 ~ 7	Configure/Read RX1_DR_OFFSET value for <i>RXParamSetupReq</i>	All
READ:PROTOCOL:RX1_DR_OFFSET?	Query only		
CONF:PROTOCOL:RX2_FREQ	400~510, 862~960	Configure/Read RX2_FREQ value in MHz for <i>RXParamSetupReq</i>	All
READ:PROTOCOL:RX2_FREQ?	Query only		
CONF:PROTOCOL:RX2_DR	DR0_SF12BW125 DR1_SF11BW125 DR2_SF10BW125 ...	Configure/Read RX2_DR value for <i>RXParamSetupReq</i>	All
READ:PROTOCOL:RX2_DR?	Query only		
CONF:PROTOCOL:PING_PERIODICITY	0 ~ 7	Configure/Read the periodicity of Ping for Class B	All
READ:PROTOCOL:PING_PERIODICITY?	Query only		
CONF:PROTOCOL:PROTOCOL_VER	LoRaWAN1.0.2 LoRaWAN1.0.3 LoRaWAN1.0.4 LoRaWAN1.1	Configure/Read the protocol version of LoRaWAN	All
READ:PROTOCOL:PROTOCOL_VER?	Query only		
CONF:PROTOCOL:NWK_KEY	128-bit HEX value	Configure/Read the NwkKey value (LoRaWAN V1.1 only)	All
READ:PROTOCOL:NWK_KEY?	Query only		
CONF:PROTOCOL:FNWKS_IKEY	128-bit HEX value	Configure/Read the FNwkSIntKey value	All

READ:PROTOCOL:FNWKS_IKEY?	Query only	(LoRaWAN V1.1 only)	
CONF:PROTOCOL:SNWKS_IKEY	128-bit HEX value	Configure/Read the SNwkSIntKey value	All
READ:PROTOCOL:SNWKS_IKEY?	Query only	(LoRaWAN V1.1 only)	
CONF:PROTOCOL:NWKS_EKEY	128-bit HEX value	Configure/Read the NwkSEncKey value	All
READ:PROTOCOL:NWKS_EKEY?	Query only	(LoRaWAN V1.1 only)	
CONF:PROTOCOL:JOIN_EUI	64-bit HEX value	Configure/Read the JoinEUI value	All
READ:PROTOCOL:JOIN_EUI?	Query only	(LoRaWAN V1.1 only)	
CONF:PROTOCOL:UPDATE_NFCNT	0 ~ 65535	Configure/Read the NFCnt value	All
READ:PROTOCOL:UPDATE_NFCNT?	Query only	(LoRaWAN V1.1 only)	
CONF:PROTOCOL:UPDATE_AFCNT	0 ~ 65535	Configure/Read the AFCnt value	All
READ:PROTOCOL:UPDATE_AFCNT?	Query only	(LoRaWAN V1.1 only)	
CONF:PROTOCOL:DL_DWELL_TIME	400ms, NO_LIMIT	Configure/Read the downlink dwell time	All
READ:PROTOCOL:DL_DWELL_TIME?	Query only		
CONF:PROTOCOL:UL_DWELL_TIME?	400ms, NO_LIMIT	Read the uplink dwell time	All
READ:PROTOCOL:UL_DWELL_TIME?	Query only		
CONF:PROTOCOL:LATITUDE	-90 ~ 90	Configure/Read the latitude value in Beacon frame for Class B	All
READ:PROTOCOL:LATITUDE?	Query only		
CONF:PROTOCOL:LONGITUDE	-180 ~ 180	Configure/Read the longitude value in Beacon frame for Class B	All
READ:PROTOCOL:LONGITUDE?	Query only		
CONF:PROTOCOL:PERIODIC_DOWNLINK	NONE CONFIRMED_DOWN UNCONFIRMED_DOWN	Configure/Read the Periodic Downlink mode for class B in EDT	All
READ:PROTOCOL: PERIODIC_DOWNLINK?	Query only		
CONF:PROTOCOL:NWK_ID	0 ~ 0x7F	Configure/Read the network id.	All
READ:PROTOCOL:NWK_ID?	Query only		
CONF:PROTOCOL:NET_ID_MSB	0 ~ 0x1FFFF	Configure/Read the MSB of net id.	All

READ:PROTOCOL:NET_ID_MSB?	Query only		
CONF:PROTOCOL:NWK_ADDR	0 ~ 0x1FFFFFFF	Configure/Read the network address.	All
READ:PROTOCOL:NWK_ADDR?	Query only		
CONF:PROTOCOL:PING_TIME_OFFSET	-1000 ~ 1000 ms	Configure/Read the Ping time offset.	All
READ:PROTOCOL:PING_TIME_OFFSET?	Query only		
CONF:PROTOCOL:MAC_RSP_SLOT	RX1 RX2	Configure/Read the MAC Response Slot in GWT	All
READ:PROTOCOL:MAC_RSP_SLOT?	Query only		
CONF:PROTOCOL:GEN_APP_KEY	128-bit HEX value	Configure/Read General Application Key	All
READ:PROTOCOL:GEN_APP_KEY?	Query only		

4.4.5 Commands for LINK

RWC5020x/5021x supports multi-mac commands in a single frame. So some commands have a <MAC_NUM> field to indicate which mac command is. RWC5020x/5021x supports multi-mac command function.

Command	Parameter Range	Description	Model
EXEC:LINK:RUN	N/A	Start link creation	All
EXEC:LINK:STOP	N/A	Stop the current link	All
READ:LINK:STATUS	Query only	Read Link running status. It will return RUNNING or STOPPED	All
EXEC:LINK:CLEAR	N/A	Clear the list of link messages and measured power data	All
READ:LINK:ACTIVATION_STATUS?	Query only	Read the status of activation procedure	All
READ:INFO_MSG?	Query only	Read the link information messages	All
EXEC:LINK:MSG_RESET	N/A	Set Read link message pointer current position. Users can read Link messages for coming in from now on using READ:LINK:MSG? command.	All

READ:LINK:MSG?	Query only	Read the link message with detail information	All
EXEC:LINK:MAC_SEND	N/A	Force RWC502x to send the defined MAC command	All
CONF:LINK:MAC_CMD_TYPE	UNCONFIRMED CONFIRMED	Configure/Read the message type of MAC Command to send to the DUT	All
READ:LINK:MAC_CMD_TYPE?	Query only		
CONF:LINK:MAC_ANS_TO	UNCONFIRMED CONFIRMED	Configure/Read the time out of MAC Answer after sending MAC Command	All
READ:LINK:MAC_ANS_TO?	Query only		
CONF:LINK:MAC_CMD_FIELD	PAYLOAD FOPTION	Configure/Read the field where MAC Command is sent	All
READ:LINK:MAC_CMD_FIELD?	Query only		
CONF:LINK:INSTANT_MAC_CMD <MAC_NUM>	For EDT, DEV_STATUS LINK_ADR DUTY_CYCLE RX_PARAM_SETUP TX_PARAM_SETUP NEW_CHANNEL DL_CHANNEL RX_TIMING_SETUP USER_DEFINED BEACON_FREQ PING_SLOT_CH FORCE_REJOIN REJOIN_SETUP ADR_SETUP	Configure/Read the MAC Command to send to the DUT	All
READ:LINK:INSTANT_MAC_CMD? <MAC_NUM>	For GWT, LINK_CHECK DEVICE_TIME DEVICE_MODE RESET_IND		
CONF:LINK:MIC_ERR_DISPLAY	OFF ON	Configure/Read the flag whether to display erroneous messages in Link Analyzer	All
READ:LINK:MIC_ERR_DISPLAY?	Query only		
CONF:LINK:ADR_DR <MAC_NUM>	DR0_SF12BW125 DR1_SF11BW125 DR2_SF10BW125 ...	Configure/Read DR value for <i>LinkADRReq</i>	All
READ:LINK:ADR_DR? <MAC_NUM>	Query only		
CONF:LINK:ADR_TXPOW <MAC_NUM>	0 ~ 7	Configure/Read TX power value for <i>LinkADRReq</i>	All

READ:LINK:ADR_TXPOW? <MAC_NUM>	Query only		
CONF:LINK:ADR_CH_MASK <MAC_NUM>	0x00 ~ 0xFF	Configure/Read CH_MASK value for	All
READ:LINK:ADR_CH_MASK? <MAC_NUM>	Query only	<i>LinkADRReq</i>	
CONF:LINK:ADR_MASK_CTRL <MAC_NUM>	0x00 ~ 0xFF	Configure/Read MASK_CTRL value for	All
READ:LINK:ADR_MASK_CTRL? <MAC_NUM>	Query only	<i>LinkADRReq</i>	
CONF:LINK:ADR_CH_MASK_OPT <MAC_NUM>	0x01 ~ 0x80	Configure/Read CH_MASK value for optional DR for	All
READ:LINK:ADR_CH_MASK_OPT? <MAC_NUM>	Query only	<i>LinkADRReq. Only one channel (bit) can be enabled</i>	
CONF:LINK:ADR_NB_TRANS <MAC_NUM>	0 ~ 15	Configure/Read NbTrans value for	All
READ:LINK:ADR_NB_TRANS? <MAC_NUM>	Query only	<i>LinkADRReq</i>	
CONF:LINK:MAX_DUTY_CYCLE <MAC_NUM>	0 ~ 15	Configure/Read the maximum duty cycle value for	All
READ:LINK:MAX_DUTY_CYCLE? <MAC_NUM>	Query only	<i>DutyCycleReq</i>	
CONF:LINK:MAX_EIRP <MAC_NUM>	8 10 12 ...	Configure/Read the maximum EIRP value in dBm for	All
READ:LINK:MAX_EIRP? <MAC_NUM>	Query only	<i>TXParamSetupReq</i>	
CONF:LINK:UL_DWELL_TIME <MAC_NUM>	NO_LIMIT 400ms	Configure/Read the uplink dwell time value for	All
READ:LINK:UL_DWELL_TIME? <MAC_NUM>	Query only	<i>TXParamSetupReq</i>	
CONF:LINK:DL_DWELL_TIME <MAC_NUM>	NO_LIMIT 400ms	Configure/Read the uplink dwell time value for	All
READ:LINK:DL_DWELL_TIME? <MAC_NUM>	Query only	<i>TXParamSetupReq</i>	
CONF:LINK:NEW_CH_MODE <MAC_NUM>	CREATE DELETE	Configure/Read the mode for	All
READ:LINK:NEW_CH_MODE? <MAC_NUM>	Query only	<i>NewChannelReq</i>	
CONF:LINK:NEW_CH_INDEX <MAC_NUM>	0 ~ 7	Configure/Read the channel index for	All
READ:LINK:NEW_CH_INDEX? <MAC_NUM>	Query only	<i>NewChannelReq</i>	
CONF:LINK:NEW_CH_MAX_DR <MAC_NUM>	0 ~ 7	Configure/Read the maximum DR for	All
READ:LINK:NEW_CH_MAX_DR? <MAC_NUM>	Query only	<i>NewChannelReq</i>	

CONF:LINK:NEW_CH_MIN_DR <MAC_NUM>	0 ~ 7	Configure/Read the minimum DR for <i>NewChannelReq</i>	All
READ:LINK:NEW_CH_MIN_DR? <MAC_NUM>	Query only		
CONF:LINK:NUM_OF_CMD	1 ~ 3	Configure/Read the number of MAC commands to be sent in a single frame	All
READ:LINK:NUM_OF_CMD?	Query only		
CONF:LINK:DL_CH_INDEX <MAC_NUM>	0 ~ 7	Configure/Read the channel index for <i>DlChannelReq</i>	All
READ:LINK:DL_CH_INDEX? <MAC_NUM>	Query only		
CONF:LINK:DL_CH_FREQ <MAC_NUM>	400 ~ 510, 862 ~ 960 MHz	Configure/Read the channel frequency for <i>DlChannelReq</i>	All
READ:LINK:DL_CH_FREQ? <MAC_NUM>	Query only		
CONF:LINK:FPORT	1 ~ 255	Configure/Read the FPORT of user-defined MAC command	All
READ:LINK:FPORT?	Query only		
CONF:LINK:PAYLOAD_SIZE	1 ~ 128	Configure/Read the Message length in byte of user-defined MAC command	All
READ:LINK:PAYLOAD_SIZE?	Query only		
CONF:LINK:PAYLOAD	250-byte HEX value	Configure/Read the Message data of user-defined MAC command	All
READ:LINK:PAYLOAD?	Query only		
CONF:LINK:FOPTS_SIZE	1 ~ 15	Configure/Read the Message length in byte of user-defined FOpts field	All
READ:LINK:FOPTS_SIZE?	Query only		
CONF:LINK:FOPTS	15-byte HEX value	Configure/Read the Message data of user-defined FOpts field	All
READ:LINK:FOPTS?	Query only		
CONF:LINK:FOPTS_PAYLOAD_SIZE	0 ~ 250	Configure/Read the Message length in byte of user-defined Payload field	All
READ:LINK:FOPTS_PAYLOAD_SIZE?	Query only		
CONF:LINK:FOPTS_PAYLOAD	250-byte HEX value	Configure/Read the Message data of user-defined Payload data	All
READ:LINK:FOPTS_PAYLOAD?	Query only		
CONF:LINK:BEACON_FREQ <MAC_NUM>	0, 862 ~ 960 MHz	Configure/Read the frequency value of Beacon frame	All
READ:LINK:BEACON_FREQ? <MAC_NUM>	Query only		
CONF:LINK:PING_DR <MAC_NUM>	DR0_SF12BW125 DR1_SF11BW125 DR2_SF10BW125 ...	Configure/Read the Data Rate used for the <u>ping-slot downlinks</u> for <i>PingSlotChannelReq</i>	All

READ:LINK:PING_DR? <MAC_NUM>	Query only		
CONF:LINK:PING_FREQ <MAC_NUM>	400 ~ 510, 862 ~ 960 MHz	Configure/Read the frequency used for the ping-slot downlinks for	All
READ:LINK:PING_FREQ? <MAC_NUM>	Query only	<i>PingSlotChannelReq</i>	
CONF:LINK:RX2_DR <MAC_NUM>	DR0_SF12BW125 DR1_SF11BW125 DR2_SF10BW125 ...	Configure/Read the Data Rate used for the RX2 channel	All
READ:LINK:RX2_DR? <MAC_NUM>	Query only		
CONF:LINK:RX2_FREQ <MAC_NUM>	400 ~ 510, 862 ~ 960 MHz	Configure/Read the frequency used for the RX2 channel	All
READ:LINK:RX2_FREQ? <MAC_NUM>	Query only		
CONF:LINK:RECEIVE_DELAY <MAC_NUM>	1 ~ 10	Configure/Read the Receive delay	All
READ:LINK:RECEIVE_DELAY? <MAC_NUM>	Query only		
CONF:LINK:RX1_DR_OFFSET <MAC_NUM>	0 ~ 7	Configure/Read the RX1 DR Offset	All
READ:LINK:RX1_DR_OFFSET? <MAC_NUM>	Query only		
CONF:LINK:REJOIN_DR <MAC_NUM>	DR0_SF12BW125 DR1_SF11BW125 DR2_SF10BW125 ...	Configure/Read the Data Rate value for	All
READ:LINK:REJOIN_DR? <MAC_NUM>	Query only	<i>ForceRejoinReq</i>	
CONF:LINK:REJOIN_TYPE <MAC_NUM>	TYPE_0, TYPE_2	Configure/Read the RejoinType value for	All
READ:LINK:REJOIN_TYPE? <MAC_NUM>	Query only	<i>ForceRejoinReq</i>	
CONF:LINK:REJOIN_RETRY <MAC_NUM>	0 ~ 7	Configure/Read the Max_Retries value for	All
READ:LINK:REJOIN_RETRY? <MAC_NUM>	Query only	<i>ForceRejoinReq</i>	
CONF:LINK:REJOIN_PERIOD <MAC_NUM>	0 ~ 7	Configure/Read the Period value for	All
READ:LINK:REJOIN_PERIOD? <MAC_NUM>	Query only	<i>ForceRejoinReq</i>	
CONF:LINK:REJOIN_MAX_TIME_N <MAC_NUM>	0 ~ 15	Configure/Read the MaxTimeN value for	All
READ:LINK:REJOIN_MAX_TIME_N? <MAC_NUM>	Query only	<i>RejoinParamSetupReq</i>	
CONF:LINK:REJOIN_MAX_CNT_N <MAC_NUM>	0 ~ 15	Configure/Read the MaxCountN value for	All
		<i>RejoinParamSetupReq</i>	

READ:LINK:REJOIN_MAX_CNT_N? <MAC_NUM>	Query only		
CONF:LINK:ADR_LIMIT_EXP <MAC_NUM>	0 ~ 15	Configure/Read the Limit_exp value for	All
READ:LINK:ADR_LIMIT_EXP? <MAC_NUM>	Query only	<i>ADRParamSetupReq</i> (ADR_ACK_LIMIT=2^Limit_exp)	
CONF:LINK:ADR_DELAY_EXP <MAC_NUM>	0 ~ 15	Configure/Read the Delay_exp value for	All
READ:LINK:ADR_DELAY_EXP? <MAC_NUM>	Query only	<i>ADRParamSetupReq</i> (ADR_ACK_DELAY=2^Delay_exp)	
CONF:LINK:TIME_DISPLAY	OFF ON	Configure/Read the flag whether to display Time parameter in Link Analyzer screen	A/B
READ:LINK:TIME_DISPLAY?	Query only		
CONF:LINK:FCNT_DISPLAY	OFF ON	Configure/Read the flag whether to display FCnt field in Link Analyzer screen	A/B
READ:LINK:FCNT_DISPLAY?	Query only		
CONF:LINK:ADR_DISPLAY	OFF ON	Configure/Read the flag whether to display ADR field in Link Analyzer screen	A/B
READ:LINK:ADR_DISPLAY?	Query only		
CONF:LINK:ACK_DISPLAY	OFF ON	Configure/Read the flag whether to display ACK field in Link Analyzer screen	A/B
READ:LINK:ACK_DISPLAY?	Query only		
CONF:LINK:CLASS_B_DISPLAY	OFF ON	Configure/Read the flag whether to display Class B field in Link Analyzer screen	A/B
READ:LINK:CLASS_B_DISPLAY?	Query only		
CONF:LINK:PORT_DISPLAY	OFF ON	Configure/Read the flag whether to display FPort field in Link Analyzer screen	A/B
READ:LINK:PORT_DISPLAY?	Query only		
CONF:LINK:MSG_TYPE_DISPLAY	OFF ON	Configure/Read the flag whether to display Message Type field in Link Analyzer screen	A/B
READ:LINK:MSG_TYPE_DISPLAY?	Query only		
CONF:LINK:POW_DISPLAY	OFF ON	Configure/Read the flag whether to display the measured power in Link Analyzer screen	A/B
READ:LINK:POW_DISPLAY?	Query only		
CONF:LINK:DR_DISPLAY	OFF ON	Configure/Read the flag whether to display DR value in Link Analyzer screen	A/B
READ:LINK:DR_DISPLAY?	Query only		

CONF:LINK:DELAY_DISPLAY	OFF ON	Configure/Read the flag whether to display RxDelay value in Link Analyzer screen	A/B
READ:LINK:DELAY_DISPLAY?	Query only		
CONF:LINK:ADRACKREQ_DISPLAY	OFF ON	Configure/Read the flag whether to display ADRACKReq field in Link Analyzer screen	A/B
READ:LINK:ADRACKREQ_DISPLAY?	Query only		
CONF:LINK:FPENDING_DISPLAY	OFF ON	Configure/Read the flag whether to display FPending field in Link Analyzer screen	A/B
READ:LINK:FPENDING_DISPLAY?	Query only		
CONF:LINK:DWELL_DISPLAY	OFF ON	Configure/Read the flag whether to display dwell time field in Link Analyzer screen	A/B
READ:LINK:DWELL_DISPLAY?	Query only		
CONF:LINK:ECHO_LEN <MAC_NUM>	1 ~ 242	Configure/Read the length of payload in bytes in EchoRequest command	All
READ:LINK:ECHO_LEN? <MAC_NUM>	Query only		
CONF:LINK:ECHO_PAYLOAD <MAC_NUM>	250-byte HEX value	Configure/Read the Message data of echo request command	All
READ:LINK:ECHO_PAYLOAD? <MAC_NUM>	Query only		
CONF:LINK:CW_TIMEOUT <MAC_NUM>	1 ~ 255	Configure/Read the timeout of CW transmission in Enable Continuous Wave Mode command	All
READ:LINK:CW_TIMEOUT? <MAC_NUM>	Query only		
CONF:LINK:CW_FREQ <MAC_NUM>	400 ~ 510 MHz 862 ~ 960 MHz	Configure/Read the frequency of CW signal in Enable Continuous Wave Mode command	All
READ:LINK:CW_FREQ? <MAC_NUM>	Query only		
CONF:LINK:CW_POW <MAC_NUM>	0 ~ 40	Configure/Read the power of CW signal in dBm in Enable Continuous Wave Mode command	All
READ:LINK:CW_POW? <MAC_NUM>	Query only		
CONF:LINK:MAC_INTERVAL	5 ~ 60	Configure/Read the minimum MAC command interval in sec. This parameter is used for Periodic Downlink in Class B&C	All
READ:LINK:MAC_INTERVAL?	Query only		
READ:LINK:MAC_SENDDL_RESULT? <MAC_NUM>	Query only	Read MAC response information after sending MAC command. For multi-mac response, it requires a MAC NUM	All

		parameter.	
READ:LINK:MAC_SEND_STATUS?	Query only	Read MAC command sending status. There are five status definitions (IDLE, STARTED, SCHEDULED, GOT_RSP, TIMEOUT). Refer to the following fig.	All
READ:LINK:DUTY_CYCLE?	Query only	Read duty cycle value displayed on Link Analyzer	All
CONF:LINK:MALFUNCTION	OFF, ON	Configure/Read malfunction activation.	All
READ:LINK:MALFUNCTION?	Query only		
CONF:LINK:MIC_ERROR	OFF, ON	Configure/Read MIC Error activation for malfunction testing.	All
READ:LINK:MIC_ERROR?	Query only		
CONF:LINK:MHDR_ERROR	OFF, ON	Configure/Read MAC Header Error activation for malfunction testing.	All
READ:LINK:MHDR_ERROR?	Query only		
CONF:LINK:XOR_MHDR	0x00 ~ 0xFF	Configure/Read exclusive OR value for MAC Header.	All
READ:LINK:XOR_MHDR?	Query only		
CONF:LINK:FHDR_ERROR	OFF, ON	Configure/Read FRAME Header Error activation for malfunction testing.	All
READ:LINK:FHDR_ERROR?	Query only		
CONF:LINK:XOR_FHDR	0x00 ~ 0xFF	Configure/Read exclusive OR value for FRAME Header.	All
READ:LINK:XOR_FHDR?	Query only		
CONF:LINK:NO_ANSWER_TO_JOIN_REQUEST	OFF, ON	Configure/Read the malfunction of No answer to JoinRequest	All
READ:LINK:NO_ANSWER_TO_JOIN_REQUEST?	Query only		
CONF:LINK:NO_ANSWER_TO_MAC_COMMAND	OFF, ON	Configure/Read the malfunction of No answer to MAC Command	All
READ:LINK:NO_ANSWER_TO_MAC_COMMAND?	Query only		
CONF:LINK:NO_ANSWER_TO_CONFIRMED_UP	OFF, ON	Configure/Read the malfunction of No answer to Confirmed Up	All
READ:LINK:NO_ANSWER_TO_CONFIRMED_UP?	Query only		
READ:LINK:FUOTA_FILE_LEN?	Query only	Read the length of FUOTA binary file	All

READ:LINK:FUOTA_FILE_NAME?	Query only	Read the name of FUOTA binary file	All
CONF:LINK:FRAG_INDEX	0~3	Configure fragment index for application layer	All
CONF:LINK:FRAG_SIZE	1~255	Configure fragment size for application layer	All
CONF:LINK:NB_FRAG	1~65535	Configure number of fragment for application layer	All
CONF:LINK:FRAG_PADDING	0~255	Configure fragment padding for application layer	All
CONF:LINK:FRAG_DESCRIPTOR	0x0 ~ 0xFFFFFFFF	Configure fragment descriptor for application layer	All
CONF:LINK:FRAG_ALGO	0~7	Configure fragment algorithm for application layer	All
READ:LINK:FRAG_PROGRESS?	Query only	Read the status of fragment progressing for application layer	All
CONF:LINK:MC_GROUP_ID	0~3	Configure multicast group id for application layer	All
CONF:LINK:MC_ADDR	0x0 ~ 0xFFFFFFFF	Configure multicast address for application layer	All
CONF:LINK:MC_FREQ	400 ~ 510, 862 ~ 960 MHz	Configure multicast frequency for application layer	All
CONF:LINK:MC_DR	DR0_SF12BW125 DR1_SF11BW125 DR2_SF10BW125 ...	Configure multicast data range for application layer	All
CONF:LINK:MC_OPTION	0~1	Configure multicast option for application layer	All
CONF:LINK:MC_INTERVAL	1~10000	Configure multicast interval between multicast packets for application layer	All
CONF:LINK:FM_REBOOT_TIME_MODE	TIME, ASAP, CANCEL	Configure firmware management reboot time mode for application layer	All
CONF:LINK:FM_REBOOT_YEAR	1900 ~ 2300	Configure firmware management reboot time(year) for application layer	All
CONF:LINK:FM_REBOOT_MONTH	1~12	Configure firmware management reboot time(month) for application layer	All
CONF:LINK:FM_REBOOT_DAY	1~31	Configure firmware management reboot	All

		time(day) for application layer	
CONF:LINK:FM_REBOOT_HOUR	0~23	Configure firmware management reboot time(hour) for application layer	All
CONF:LINK:FM_REBOOT_MINUTE	0~59	Configure firmware management reboot time(minute) for application layer	All
CONF:LINK:FM_REBOOT_SECOND	0~59	Configure firmware management reboot time(second) for application layer	All
CONF:LINK:FM_REBOOT_CD	0~0xFFFFFFFF	Configure firmware management reboot countdown value for application layer	All
CONF:LINK:FM_NEXT_FW_VER	0x0~0xFFFFFFFF	Configure next firmware version of firmware management for application layer	All
CONF:LINK:FM_DEL_FW_VER	0x0~0xFFFFFFFF	Configure delete firmware version of firmware management for application layer	All
CONF:LINK:APP_TIME_PERIOD	0~15	Configure the application layer time request period	All
CONF:LINK:APP_TIME_NB_TRANS	0~7	Configuring the number of transfers for the time synchronization application layer	All

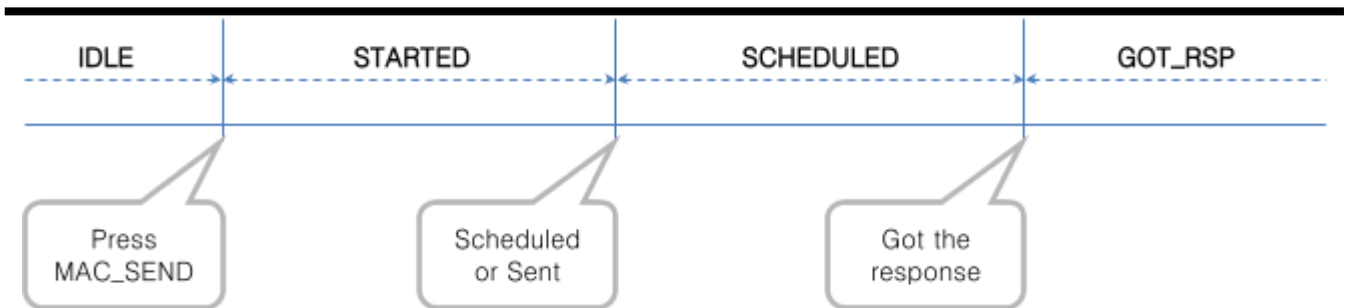

4.4.6 Commands for POW_MEASURE

Command	Parameter Range	Description	Model
CONF:POWER:SCALE	AUTO MANUAL	Configure/Read the scaling mode of Y-axis	A/B/M

READ:POWER:SCALE?	Query only		
CONF:POWER:MAX_Y	40 ~ -60	Configure/Read the maximum value of Y-axis	A/B/M
READ:POWER:MAX_Y?	Query only		
CONF:POWER:MIN_Y	30 ~ -80	Configure/Read the minimum value of Y-axis	A/B/M
READ:POWER:MIN_Y?	Query only		
READ:POWER:ALL:NUM?	Query only	Read the number of received packets and the maximum, average, or minimum DUT power of all the measured	A/B/M
READ:POWER:ALL:MAX?	Query only		
READ:POWER:ALL:AVG?	Query only		
READ:POWER:ALL:MIN?	Query only		
READ:POWER:SF7:NUM?	Query only	Read the number of received packets and the maximum, average, or minimum DUT power using SF7 of all the measured	A/B/M
READ:POWER:SF7:MAX?	Query only		
READ:POWER:SF7:AVG?	Query only		
READ:POWER:SF7:MIN?	Query only		
READ:POWER:SF8:NUM?	Query only	Read the number of received packets and the maximum, average, or minimum DUT power using SF8 of all the measured	A/B/M
READ:POWER:SF8:MAX?	Query only		
READ:POWER:SF8:AVG?	Query only		
READ:POWER:SF8:MIN?	Query only		
READ:POWER:SF9:NUM?	Query only	Read the number of received packets and the maximum, average, or minimum DUT power using SF9 of all the measured	A/B/M
READ:POWER:SF9:MAX?	Query only		
READ:POWER:SF9:AVG?	Query only		
READ:POWER:SF9:MIN?	Query only		
READ:POWER:SF10:NUM?	Query only	Read the number of received packets and the maximum, average, or minimum DUT power using SF10 of all the measured	A/B/M
READ:POWER:SF10:MAX?	Query only		
READ:POWER:SF10:AVG?	Query only		
READ:POWER:SF10:MIN?	Query only		
READ:POWER:SF11:NUM?	Query only	Read the number of received packets and the maximum, average, or minimum DUT power using SF11 of all the measured	A/B/M
READ:POWER:SF11:MAX?	Query only		
READ:POWER:SF11:AVG?	Query only		

READ:POWER:SF11:MIN?	Query only		
READ:POWER:SF12:NUM?	Query only	Read the number of received packets and the maximum, average, or minimum DUT power using SF12 of all the measured	A/B/M
READ:POWER:SF12:MAX?	Query only		
READ:POWER:SF12:AVG?	Query only		
READ:POWER:SF12:MIN?	Query only		
READ:POWER:CH_0:NUM?	Query only	Read the number of received packets and the maximum, average, or minimum DUT power using CH_0 of all the measured	A/B/M
READ:POWER:CH_0:MAX?	Query only		
READ:POWER:CH_0:AVG?	Query only		
READ:POWER:CH_0:MIN?	Query only		
READ:POWER:CH_1:NUM?	Query only	Read the number of received packets and the maximum, average, or minimum DUT power using CH_1 of all the measured	A/B/M
READ:POWER:CH_1:MAX?	Query only		
READ:POWER:CH_1:AVG?	Query only		
READ:POWER:CH_1:MIN?	Query only		
READ:POWER:CH_2:NUM?	Query only	Read the number of received packets and the maximum, average, or minimum DUT power using CH_2 of all the measured	A/B/M
READ:POWER:CH_2:MAX?	Query only		
READ:POWER:CH_2:AVG?	Query only		
READ:POWER:CH_2:MIN?	Query only		
READ:POWER:CH_3:NUM?	Query only	Read the number of received packets and the maximum, average, or minimum DUT power using CH_3 of all the measured	A/B/M
READ:POWER:CH_3:MAX?	Query only		
READ:POWER:CH_3:AVG?	Query only		
READ:POWER:CH_3:MIN?	Query only		
READ:POWER:CH_4:NUM?	Query only	Read the number of received packets and the maximum, average, or minimum DUT power using CH_4 of all the measured	A/B/M
READ:POWER:CH_4:MAX?	Query only		
READ:POWER:CH_4:AVG?	Query only		
READ:POWER:CH_4:MIN?	Query only		
READ:POWER:CH_5:NUM?	Query only	Read the number of received packets and the maximum, average, or minimum DUT power using CH_5 of all the measured	A/B/M
READ:POWER:CH_5:MAX?	Query only		
READ:POWER:CH_5:AVG?	Query only		
READ:POWER:CH_5:MIN?	Query only		

READ:POWER:CH_6:NUM?	Query only	Read the number of received packets and	
READ:POWER:CH_6:MAX?	Query only	the maximum,	A/B/M
READ:POWER:CH_6:AVG?	Query only	average, or minimum	
READ:POWER:CH_6:MIN?	Query only	DUT power using	
		CH_6 of all the	
		measured	
READ:POWER:CH_7:NUM?	Query only	Read the number of received packets and	
READ:POWER:CH_7:MAX?	Query only	the maximum,	A/B/M
READ:POWER:CH_7:AVG?	Query only	average, or minimum	
READ:POWER:CH_7:MIN?	Query only	DUT power using	
		CH_7 of all the	
		measured	
READ:POWER:RX2:NUM?	Query only	Read the number of received packets and	
READ:POWER:RX2:MAX?	Query only	the maximum,	A/B/M
READ:POWER:RX2:AVG?	Query only	average, or minimum	
READ:POWER:RX2:MIN?	Query only	DUT power using	
		RX2 of all the	
		measured	
EXEC:POWER:RUN	N/A	Start the power	A/B/M
		measure test	
EXEC:POWER:STOP	N/A	Stop the power	A/B/M
		measure test	
CONF:POWER:MODE	SYNC_TO_LINK SCENARIO	Configure/Read the	A/B/M
		operating mode for	
READ:POWER:MODE?	Query only	power measure test	
CONF: POWER:SCENARIO	NORMAL_UL CERTI_DL_CNT CERTI_CW	Configure/Read the	A/B/M
		scenario for power	
READ: POWER:SCENARIO?	Query only	measure test	
CONF:POWER:TARGET_CH_MASK	0x01 ~ 0xFF	Configure/Read the	
		Channel mask value	
READ:POWER:TARGET_CH_MASK?	Query only	to be used in power	A/B/M
		measure Test. This	
		parameter allows	
		power measure testing	
		for specific channels.	
CONF:POWER:TARGET_CH_MASK_OPT	0x01 ~ 0x80	Configure/Read	
		CH_MASK value for	
READ:POWER:TARGET_CH_MASK_OPT?	Query only	optional DR for	A/B/M
		power measurement.	
		<i>Only one channel</i>	
		<i>(bit) can be enabled</i>	
CONF:POWER:ADR_POWER	0 ~ 10	Configure/Read the	A/B/M
		power index value to	
READ: POWER:ADR_POWER?	Query only	be used in power	
		measure Test	
CONF:POWER:UL_DR	DR0_SF12BW125 DR1_SF11BW125 DR2_SF10BW125	Configure/Read the	A/B/M
		DR value to be used	
		in power measure	

...		Test	
READ: POWER:UL_DR?	Query only		
CONF:POWER:PKT_NUM	3 ~ 100	Configure/Read the Minimum packet number for each channel in power measure Test	A/B/M
READ: POWER:PKT_NUM?	Query only		
CONF:POWER:CW_TIMEOUT	5 ~ 65535	Configure/Read the CW timeout for CERTI_CW scenario in power measure Test	A/B/M
READ: POWER:CW_TIMEOUT?	Query only		
CONF:POWER:CW_FREQ	400 ~ 510 MHz 862 ~ 960 MHz	Configure/Read the CW freq for CERTI_CW scenario in power measure Test	A/B/M
READ: POWER:CW_FREQ?	Query only		
CONF:POWER:CW_POW	0 ~ 40dBm	Configure/Read the CW power for CERTI_CW scenario in power measure Test	A/B/M
READ: POWER:CW_POW?	Query only		
EXEC:POWER:CLEAR_DATA	N/A	Clear previous measured values during Power measurement and restart measuring	A/B/M

4.4.7 Commands for SENSITIVITY

Command	Parameter Range	Description	Model
EXEC:SENSITIVITY:RUN	N/A	Start the sensitivity test	A/B/M
EXEC:SENSITIVITY:STOP	N/A	Stop the sensitivity test	A/B/M
EXEC:SENSITIVITY:RESTART	N/A	Re-start the sensitivity test without stopping	A/B/M
CONF:SENSITIVITY:SCENARIO	CERTI_ECHO NORMAL UP	Configure/Read the operating mode for sensitivity test	A/B/M
READ:SENSITIVITY:SCENARIO?	Query only		
CONF:SENSITIVITY:PACKET_NUM	5 ~ 1000	Configure/Read the number of repetition for each test point	A/B/M
READ:SENSITIVITY:PACKET_NUM?	Query only		
CONF:SENSITIVITY:START_POW	-10 ~ -143	Configure/Read the start power value	A/B/M
READ:SENSITIVITY:START_POW?	Query only		

READ:SENSITIVITY:STOP_POW?	Query only	Read the stop power value	A/B/M
CONF:SENSITIVITY:NUM_POW	1 ~ 100	Configure/Read the number of power values	A/B/M
READ:SENSITIVITY:NUM_POW?	Query only		
CONF:SENSITIVITY:STEP_POW	1 ~ 20	Configure/Read the step value of power	A/B/M
READ:SENSITIVITY:STEP_POW?	Query only		
CONF:SENSITIVITY:TARGET_PER	0 ~ 0.5	Configure/Read the value of users' target PER	A/B/M
READ:SENSITIVITY:TARGET_PER?	Query only		
READ:SENSITIVITY:STATUS?	Query only	Read the run status of the current test	A/B/M
READ:SENSITIVITY:PROGRESS?	Query only	Read the progress of sensitivity test	A/B/M
READ:SENSITIVITY:LEVEL?	Query only	Read the resultant sensitivity level, [dBm]	A/B/M
READ:SENSITIVITY:PER?	Query only	Read the resultant PER value at sensitivity level	A/B/M
CONF:SENSITIVITY:DOWNLINK_SLOT	For EDT, RX1 RX2 PING (Class B)	Configure/Read the selection of downlink slot (RX window)	A/B/M
READ:SENSITIVITY:DOWNLINK_SLOT?	Query only		
CONF:SENSITIVITY:TARGET_CH_MASK	0x01 ~ 0xFF	Configure/Read the Channel mask value to be used in Sensitivity Test. This parameter allows sensitivity testing for specific channels.	A/B/M
READ:SENSITIVITY:TARGET_CH_MASK?	Query only		
CONF: SENSITIVITY:TARGET_CH_MASK_OPT	0x01 ~ 0x80	Configure/Read CH_MASK value for optional DR for Sensitivity Test. <i>Only one channel (bit) can be enabled</i>	A/B/M
READ: SENSITIVITY:TARGET_CH_MASK_OPT?	Query only		
CONF:SENSITIVITY:TARGET_DR	DR0_SF12BW125 DR1_SF11BW125 DR2_SF10BW125 ...	Configure/Read the DR value to be used in Sensitivity Test	A/B/M
READ:SENSITIVITY:TARGET_DR?	Query only		
CONF:SENSITIVITY:FPORT	1 ~ 255	Configure/Read the FPORT of user-defined MAC command	A/B/M

READ:SENSITIVITY:FPORT?	Query only		
CONF:SENSITIVITY:PAYLOAD_SIZE	1 ~ 128	Configure/Read the Message length in byte of user-defined MAC command	A/B/M
READ:SENSITIVITY:PAYLOAD_SIZE?	Query only		
CONF:SENSITIVITY:PAYLOAD	128-byte HEX value	Configure/Read the Message data of user-defined MAC command	A/B/M
READ:SENSITIVITY:PAYLOAD?	Query only		
CONF:SENSITIVITY:RX2_FREQ	Frequency value in Hz	Configure/Read the RX2 Frequency for RX2 channel sensitivity test	A/B/M
READ:SENSITIVITY:RX2_FREQ?	Query only		
READ:SENSITIVITY:PER_RESULT? <index>	Query only	Read the PER value which is tested. Index is the power index value.	A/B/M

4.4.8 Commands for NST

Command	Parameter Range	Description	Model
EXEC:NST:TX:RUN	N/A	Run the Signal Generator to transmit test packets to DUT	A/B/M
EXEC:NST:TX:STOP	N/A	Stop the Signal Generator	A/B/M
EXEC:NST:TX:CLEAR	N/A	Clear previous measured data	A/B/M
READ:NST:TX:STATUS?	N/A	Read the number of packets transmitted after starting. It will return IDLE if not started.	A/B/M
CONF:NST:TX:REPEAT_NUM	0 ~ 10000	Configure/Read the number of repetition; 0 means infinite transmission	A/B/M
READ:NST:TX:REPEAT_NUM?	Query only		
CONF:NST:TX:MODULATION	LORA FSK CW	Configure/Read the TX mode of Non-signaling test	A/B/M
READ:NST:TX:MODULATION?	Query only		
CONF:NST:TX:PACKET_INTERVAL	0.01 ~ 1000	Configure/Read the interval in sec between consecutive LoRa TX	A/B/M

READ:NST:TX:PACKET_INTERVAL?	Query only	frames	
CONF:NST:TX:BW	500 250 125	Configure/Read the BW of LoRa TX frame	A/B/M
READ:NST:TX:BW?	Query only		
CONF:NST:TX:SF	SF7 SF8 SF9 SF10 SF11 SF12	Configure/Read the Spreading Factor of LoRa TX frame	A/B/M
READ:NST:TX:SF?	Query only		
CONF:NST:TX:CR	4_5 4_6 4_7 4_8 NO_CRC	Configure/Read the Coding Rate of LoRa TX frame	A/B/M
READ:NST:TX:CR?	Query only		
CONF:NST:TX:PREAMBLE_SIZE	2 ~ 12	Configure/Read the Preamble size of LoRa TX frame	A/B/M
READ:NST:TX:PREAMBLE_SIZE?	Query only		
CONF:NST:TX:PAYLOAD_SIZE	8 ~ 256	Configure/Read the Payload size of LoRa TX frame	A/B/M
READ:NST:TX:PAYLOAD_SIZE?	Query only		
CONF:NST:TX:PAYLOAD	128-byte HEX value	Configure/Read the Payload data of LoRa TX frame	A/B/M
READ:NST:TX:PAYLOAD?	Query only		
CONF:NST:TX:NETWORK	PRIVATE PUBLIC	Configure/Read the Sync word in LoRa modulation: 0x12 for private network 0x34 for public network	A/B/M
READ:NST:TX:NETWORK?	Query only		
CONF:NST:TX:FM_DEVIATION	10 ~ 100 kHz	Configure/Read the FM deviation value for FSK Modulation	A/B/M
READ:NST:TX:FM_DEVIATION?	Query only		
CONF:NST:TX:DATA_RATE	1 ~ 128 kHz	Configure/Read the Data Rate value for FSK Modulation	A/B/M
READ:NST:TX:DATA_RATE?	Query only		
CONF:NST:TX:SYNC_WORD_SIZE	1 ~ 8 byte	Configure/Read the Sync Word size for FSK Modulation	A/B/M
READ:NST:TX:SYNC_WORD_SIZE?	Query only		

CONF:NST:TX:SYNC_WORD		Configure/Read the Sync Word for FSK Modulation	A/B/M
READ:NST:TX:SYNC_WORD?	Query only		
CONF:NST:TX:TX_POLARITY	NORMAL INVERSE	Configure/Read the TX signal polarity for FSK Modulation	A/B/M
READ:NST:TX:TX_POLARITY?	Query only		
CONF:NST:TX:IMPLICIT_HEADER	OFF, ON	Configure/Read the TX implicit header option	A/B/M
READ:NST:TX:IMPLICIT_HEADER?	Query only		
EXEC:NST:RX:RUN	N/A	Run the Signal Analyzer to receive test packets from DUT	A/B/M
EXEC:NST:RX:STOP	N/A	Stop the Signal Analyzer	A/B/M
EXEC:NST:RX:CLEAR	N/A	Clear previous measured data	A/B/M
CONF:NST:RX:MODE	LORA FSK	Configure/Read the RX mode of Non-signaling test	A/B/M
READ:NST:RX:MODE?	Query only		
CONF:NST:RX:BW	500 250 125	Configure/Read the BW in kHz of LoRa RX frame	A/B/M
READ:NST:RX:BW?	Query only		
CONF:NST:RX:SF	SF7 SF8 SF9 SF10 SF11 SF12 ANY	Configure/Read the Spreading Factor of LoRa RX frame	A/B/M
READ:NST:RX:SF?	Query only		
CONF:NST:RX:NETWORK	PRIVATE PUBLIC	Configure/Read the Sync word in LoRa modulation: 0x12 for private network 0x34 for public network	A/B/M
READ:NST:RX:NETWORK?	Query only		
CONF:NST:RX:PREAMBLE_SIZE		Configure/Read the Preamble size in LoRa modulation	A/B/M
READ:NST:RX:PREAMBLE_SIZE?	Query only		
CONF:NST:RX:CR	CRC NO_CRC	Configure/Read the CR of LoRa RX frame	A/B/M
READ:NST:RX:CR?	Query only		
READ:NST:RX:POW_NUM?	Query only	Read the number of received packets and	A/B/M

READ:NST:RX:POW_MAX?	Query only	the maximum, average, or minimum DUT power of all the measured	
READ:NST:RX:POW_AVG?	Query only		
READ:NST:RX:POW_MIN?	Query only		
READ:NST:RX:CW_POW?	Query only	Read RX power value. This command can be executed any time any mode.	A/B/M
READ:NST:RX:CW_FREQ?	Query only	Read RX Frequency value. This command can be executed any time any mode. It is available only in RWC5020B/M.	B/M
CONF:NST:RX:FCNT_AVG_N	1 ~ 10	Configure/Read the running average number of frequency counter value	A/B/M
READ:NST:RX:FCNT_AVG_N?	Query only		
CONF:NST:RX:DATA_RATE	1 ~ 128 kHz	Configure/Read the Data Rate value for FSK Modulation	A/B/M
READ:NST:RX:DATA_RATE?	Query only		
CONF:NST:RX:SYNC_WORD_SIZE	1 ~ 8 byte	Configure/Read the Sync Word size for FSK Modulation	A/B/M
READ:NST:RX:SYNC_WORD_SIZE?	Query only		
CONF:NST:RX:SYNC_WORD		Configure/Read the Sync Word for FSK Modulation	A/B/M
READ:NST:RX:SYNC_WORD?	Query only		
CONF:NST:RX:RX_POLARITY	NORMAL INVERSE	Configure/Read the RX signal polarity for FSK Modulation	A/B/M
READ:NST:RX:RX_POLARITY?	Query only		
CONF:NST:RX:IMPLICIT_HEADER	OFF, ON	Configure/Read the RX implicit header option	A/B/M
READ:NST:RX:IMPLICIT_HEADER?	Query only		
CONF:NST:RX:IMPLICIT_CR	4_5 4_6 4_7 4_8 NO_CRC	Configure/Read the RX implicit CR	A/B/M
READ:NST:RX:IMPLICIT_CR?	Query only		
CONF:NST:RX:IMPLICIT_PAYLOAD_SIZE	0 ~ 255 byte	Configure/Read the RX implicit payload size	A/B/M
READ:NST:RX:IMPLICIT_PAYLOAD_SIZE?	Query only		
CONF:NST:MFG:PER_CRITERIA	0.001 ~ 1	Configure/Read the user's criteria of PER in MFG test	A/B/M
READ:NST:MFG:PER_CRITERIA?	Query only		

CONF:NST:MFG:POW_CRITERIA_UPPER	-150 ~ 30	Configure/Read the user's upper criteria of TX Power in MFG test	A/B/M
READ:NST:MFG:POW_CRITERIA_UPPER?	Query only		
CONF:NST:MFG:POW_CRITERIA_LOWER	-150 ~ 30	Configure/Read the user's lower criteria of TX Power in MFG test	A/B/M
READ:NST:MFG:POW_CRITERIA_LOWER?	Query only		
READ:NST:MFG:PER?	Query only	Read the result value of PER measurement in MFG test	A/B/M
READ:NST:MFG:POW?	Query only	Read the result value of Power measurement in MFG test	A/B/M
READ:NST:MFG:STATUS?	Query only	Read the run status in MFG test; STOPPED, IDLE, PASS or FAIL, TIME_OUT, WAIT_REPORT, BUSY	A/B/M
CONF:NST:MFG:TIME_OUT	1 ~ 100	Configure/Read the timeout to wait trigger from DUT in MFG test	A/B/M
READ:NST:MFG:TIME_OUT?	Query only		
CONF:NST:MFG:MODE	LORA FSK	Configure/Read the mode of MFG test	A/B/M
READ:NST:MFG:MODE?	Query only		
CONF:NST:MFG:PACKET_INTERVAL	0.01 ~ 1000	Configure/Read the interval in sec between consecutive LoRa TX frames in MFG test	A/B/M
READ:NST:MFG:PACKET_INTERVAL?	Query only		
CONF:NST:MFG:BW	500, 250, 125	Configure/Read the BW in kHz of LoRa TX frame in MFG test	A/B/M
READ:NST:MFG:BW?	Query only		
CONF:NST:MFG:SF	SF7 ~ SF12, ANY	Configure/Read the Spreading Factor of LoRa TX frame in MFG test	A/B/M
READ:NST:MFG:SF?	Query only		
CONF:NST:MFG:CR	4_5, 4_6, 4_7, 4_8, NO_CRC	Configure/Read the Coding Rate of LoRa TX frame in MFG test	A/B/M
READ:NST:MFG:CR?	Query only		
CONF:NST:MFG:PAYLOAD_SIZE	0 ~ 250	Configure/Read the Payload size of LoRa TX frame in MFG test	A/B/M
READ:NST:MFG:PAYLOAD_SIZE?	Query only		
CONF:NST:MFG:PAYLOAD	128-byte HEX value	Configure/Read the Payload data of LoRa TX frame	A/B/M
READ:NST:MFG:PAYLOAD?	Query only		
CONF:NST:MFG:PREAMBLE_SIZE	2 ~ 12	Configure/Read the Preamble size of LoRa TX frame in MFG test	A/B/M

READ:NST:MFG:PREAMBLE_SIZE?	Query only		
EXEC:NST:MFG:RUN	N/A	Run MFG test	A/B/M
EXEC:NST:MFG:STOP	N/A	Stop MFG test	A/B/M
CONF:NST:MFG:REPEAT_NUM	0:INFINITY 1 ~ 10000	Configure/Read the number of frame transmission in MFG test	A/B/M
READ:NST:MFG:REPEAT_NUM?	Query only		
CONF:NST:MFG:NETWORK	PUBLIC PRIVATE	Configure/Read the Sync word in LoRa modulation in MFG test: 0x12 for private network 0x34 for public network	A/B/M
READ:NST:MFG:NETWORK?	Query only		
CONF:NST:MFG:FM_DEVIATION	10 ~ 100 kHz	Configure/Read the FM deviation value for FSK Modulation	A/B/M
READ:NST:MFG:FM_DEVIATION?	Query only		
CONF:NST:MFG:DATA_RATE	1 ~ 128 kHz	Configure/Read the Data Rate value for FSK Modulation	A/B/M
READ:NST:MFG:DATA_RATE?	Query only		
CONF:NST:MFG:SYNC_WORD_SIZE	1 ~ 8 byte	Configure/Read the Sync Word size for FSK Modulation	A/B/M
READ:NST:MFG:SYNC_WORD_SIZE?	Query only		
CONF:NST:MFG:SYNC_WORD		Configure/Read the Sync Word for FSK Modulation	A/B/M
READ:NST:MFG:SYNC_WORD?	Query only		
CONF:NST:MFG:TX_POLARITY	NORMAL INVERSE	Configure/Read the TX signal polarity for FSK Modulation	A/B/M
READ:NST:MFG:TX_POLARITY?	Query only		
CONF:NST:MFG:RX_POLARITY	NORMAL INVERSE	Configure/Read the RX signal polarity for FSK Modulation	A/B/M
READ:NST:MFG:RX_POLARITY?	Query only		
READ:NST:MFG:DUT_INFO?	Query only	Read the user data received from DUT at start of MFG test, e.g. a serial number	A/B/M

4.4.9 Commands for SYSTEM

Command	Parameter Range	Description	
READ:SYSTEM:SW_VERSION?	Query only	Read the software version	All
CONF:SYSTEM:REF_CLK	INT EXT	Configure/Read the selection of source for the reference clock	A/B/M
READ:SYSTEM:REF_CLK?	Query only		
READ:SYSTEM:SERIAL_NUM?	Query only	Read the serial number of Tester	All
READ:SYSTEM:OPTION_GWT?	Query only	Read the software option information about Gateway Test	All
READ:SYSTEM:OPTION_EDT?	Query only	Read the software option information about End Device Test	All
READ:SYSTEM:OPTION_NST?	Query only	Read the software option information about Non-signaling Test	All
READ:SYSTEM:OPTION_CERTI_EU?	Query only	Read the software option information about Certification test of EU868	All
READ:SYSTEM:OPTION_CERTI_SKT?	Query only	Read the software option information about Certification test of SKT	All
READ:SYSTEM:OPTION_CERTI_US?	Query only	Read the software option information about Certification test of US915	All
READ:SYSTEM:OPTION_CERTI_AS?	Query only	Read the software option information about Certification test of AS923	All
READ:SYSTEM:OPTION_CERTI_KR?	Query only	Read the software option information about Certification test of KR920	All
READ:SYSTEM:OPTION_CERTI_AU?	Query only	Read the software option information about Certification test of AU915	All
READ:SYSTEM:OPTION_CERTI_RU?	Query only	Read the software option information about Certification test of RU865	All

READ:SYSTEM:OPTION_CERTI_IL?	Query only	Read the software option information about Certification test of IL917	All
READ:SYSTEM:OPTION_CERTI_EU433?	Query only	Read the software option information about Certification test of EU433	All
CONF:SYSTEM:IP_TYPE	DYNAMIC STATIC	Configure/Read the ip type. This command should be executed via the RS232C.	All
READ:SYSTEM:IP_TYPE?	Query only		
CONF:SYSTEM:IP_ADDR	xxx.xxx.xxx.xxx	Configure/Read the ip address (IPv4). This command should be executed via the RS232C.	All
READ:SYSTEM:IP_ADDR?	Query only		

V. Revision History

Version	Date	Description																																																				
V1.33	2021.10.12	<ul style="list-style-type: none"> - Firmware version: V1.33 - Added AS923-4 regional parameter. - Removed the temporary added KZ-865 regional parameter. - Removed the temporary added IL-917 regional parameter. <table border="1"> <thead> <tr> <th colspan="2">Commands for PROTOCOL Parameters</th> </tr> </thead> <tbody> <tr> <td>CONF:PROTOCOL:GEN_APP_KEY</td> <td>deleted</td> </tr> <tr> <td>READ:PROTOCOL:GEN_APP_KEY?</td> <td>deleted</td> </tr> <tr> <th colspan="2">Commands for LINK Parameters</th> </tr> <tr> <td>CONF:LINK:MC_KEY</td> <td>deleted</td> </tr> <tr> <th colspan="2">Commands for POWER_MEASURE parameters</th> </tr> <tr> <td colspan="2"> </td> </tr> <tr> <th colspan="2">Commands for SENSITIVITY parameters</th> </tr> <tr> <td>CONF:SENSITIVITY:TARGET_DL_CH</td> <td>deleted</td> </tr> <tr> <td>READ:SENSITIVITY:TARGET_DL_CH?</td> <td>deleted</td> </tr> <tr> <th colspan="2">Commands for RF Parameters</th> </tr> <tr> <td colspan="2"> </td> </tr> <tr> <th colspan="2">Commands for NST Parameters</th> </tr> <tr> <td colspan="2"> </td> </tr> <tr> <th colspan="2">Commands for SYSTEM Parameters</th> </tr> <tr> <td colspan="2"> </td> </tr> <tr> <td colspan="2"> </td> </tr> </tbody> </table>	Commands for PROTOCOL Parameters		CONF:PROTOCOL:GEN_APP_KEY	deleted	READ:PROTOCOL:GEN_APP_KEY?	deleted	Commands for LINK Parameters		CONF:LINK:MC_KEY	deleted	Commands for POWER_MEASURE parameters				Commands for SENSITIVITY parameters		CONF:SENSITIVITY:TARGET_DL_CH	deleted	READ:SENSITIVITY:TARGET_DL_CH?	deleted	Commands for RF Parameters				Commands for NST Parameters				Commands for SYSTEM Parameters																							
Commands for PROTOCOL Parameters																																																						
CONF:PROTOCOL:GEN_APP_KEY	deleted																																																					
READ:PROTOCOL:GEN_APP_KEY?	deleted																																																					
Commands for LINK Parameters																																																						
CONF:LINK:MC_KEY	deleted																																																					
Commands for POWER_MEASURE parameters																																																						
Commands for SENSITIVITY parameters																																																						
CONF:SENSITIVITY:TARGET_DL_CH	deleted																																																					
READ:SENSITIVITY:TARGET_DL_CH?	deleted																																																					
Commands for RF Parameters																																																						
Commands for NST Parameters																																																						
Commands for SYSTEM Parameters																																																						
V1.32	2021.04.30	<ul style="list-style-type: none"> - Firmware version: V1.32 - Separate LoRaWAN1.0.3 Protocol version parameter to LoRaWAN1.0.2 and LoRaWAN1.0.3 - Add RX_AGC for the NST function. <table border="1"> <thead> <tr> <th colspan="2">Commands for PROTOCOL Parameters</th> </tr> </thead> <tbody> <tr> <td>CONF:PROTOCOL:CLAA_MODE</td> <td>deleted</td> </tr> <tr> <td>READ:PROTOCOL:CLAA_MODE?</td> <td>deleted</td> </tr> <tr> <th colspan="2">Commands for LINK Parameters</th> </tr> <tr> <td>CONF:LINK:ADR_MORE_CH_MASK</td> <td>deleted</td> </tr> <tr> <td>READ:LINK:ADR_MORE_CH_MASK?</td> <td>deleted</td> </tr> <tr> <td>CONF:LINK:ADR_CH_MASK2</td> <td>deleted</td> </tr> <tr> <td>READ:LINK:ADR_CH_MASK2?</td> <td>deleted</td> </tr> <tr> <td>CONF:LINK:ADR_CH_MASK3</td> <td>deleted</td> </tr> <tr> <td>READ:LINK:ADR_CH_MASK3?</td> <td>deleted</td> </tr> <tr> <td>CONF:LINK:ADR_MASK2_CTRL</td> <td>deleted</td> </tr> <tr> <td>READ:LINK:ADR_MASK2_CTRL?</td> <td>deleted</td> </tr> <tr> <td>CONF:LINK:ADR_MASK3_CTRL</td> <td>deleted</td> </tr> <tr> <td>READ:LINK:ADR_MASK3_CTRL?</td> <td>deleted</td> </tr> <tr> <th colspan="2">Commands for POWER_MEASURE parameters</th> </tr> <tr> <td colspan="2"> </td> </tr> <tr> <th colspan="2">Commands for SENSITIVITY parameters</th> </tr> <tr> <td colspan="2"> </td> </tr> <tr> <th colspan="2">Commands for RF Parameters</th> </tr> <tr> <td colspan="2"> </td> </tr> <tr> <th colspan="2">Commands for NST Parameters</th> </tr> <tr> <td>CONF:NST:RX:FCNT_AVG_N</td> <td>added</td> </tr> <tr> <td>READ:NST:RX:FCNT_AVG_N?</td> <td>added</td> </tr> <tr> <th colspan="2">Commands for SYSTEM Parameters</th> </tr> <tr> <td>READ:SYSTEM:OPTION_CERTI_AU?</td> <td>added</td> </tr> <tr> <td>READ:SYSTEM:OPTION_CERTI_RU?</td> <td>added</td> </tr> </tbody> </table>	Commands for PROTOCOL Parameters		CONF:PROTOCOL:CLAA_MODE	deleted	READ:PROTOCOL:CLAA_MODE?	deleted	Commands for LINK Parameters		CONF:LINK:ADR_MORE_CH_MASK	deleted	READ:LINK:ADR_MORE_CH_MASK?	deleted	CONF:LINK:ADR_CH_MASK2	deleted	READ:LINK:ADR_CH_MASK2?	deleted	CONF:LINK:ADR_CH_MASK3	deleted	READ:LINK:ADR_CH_MASK3?	deleted	CONF:LINK:ADR_MASK2_CTRL	deleted	READ:LINK:ADR_MASK2_CTRL?	deleted	CONF:LINK:ADR_MASK3_CTRL	deleted	READ:LINK:ADR_MASK3_CTRL?	deleted	Commands for POWER_MEASURE parameters				Commands for SENSITIVITY parameters				Commands for RF Parameters				Commands for NST Parameters		CONF:NST:RX:FCNT_AVG_N	added	READ:NST:RX:FCNT_AVG_N?	added	Commands for SYSTEM Parameters		READ:SYSTEM:OPTION_CERTI_AU?	added	READ:SYSTEM:OPTION_CERTI_RU?	added
Commands for PROTOCOL Parameters																																																						
CONF:PROTOCOL:CLAA_MODE	deleted																																																					
READ:PROTOCOL:CLAA_MODE?	deleted																																																					
Commands for LINK Parameters																																																						
CONF:LINK:ADR_MORE_CH_MASK	deleted																																																					
READ:LINK:ADR_MORE_CH_MASK?	deleted																																																					
CONF:LINK:ADR_CH_MASK2	deleted																																																					
READ:LINK:ADR_CH_MASK2?	deleted																																																					
CONF:LINK:ADR_CH_MASK3	deleted																																																					
READ:LINK:ADR_CH_MASK3?	deleted																																																					
CONF:LINK:ADR_MASK2_CTRL	deleted																																																					
READ:LINK:ADR_MASK2_CTRL?	deleted																																																					
CONF:LINK:ADR_MASK3_CTRL	deleted																																																					
READ:LINK:ADR_MASK3_CTRL?	deleted																																																					
Commands for POWER_MEASURE parameters																																																						
Commands for SENSITIVITY parameters																																																						
Commands for RF Parameters																																																						
Commands for NST Parameters																																																						
CONF:NST:RX:FCNT_AVG_N	added																																																					
READ:NST:RX:FCNT_AVG_N?	added																																																					
Commands for SYSTEM Parameters																																																						
READ:SYSTEM:OPTION_CERTI_AU?	added																																																					
READ:SYSTEM:OPTION_CERTI_RU?	added																																																					

		<table border="1"> <tr> <td>READ:SYSTEM:OPTION CERTI IL?</td> <td>added</td> </tr> <tr> <td>READ:SYSTEM:OPTION CERTI EU433?</td> <td>added</td> </tr> <tr> <td></td> <td></td> </tr> <tr> <td></td> <td></td> </tr> </table>	READ:SYSTEM:OPTION CERTI IL?	added	READ:SYSTEM:OPTION CERTI EU433?	added																																																		
READ:SYSTEM:OPTION CERTI IL?	added																																																							
READ:SYSTEM:OPTION CERTI EU433?	added																																																							
V1.31	2021.01.31	<p>- Firmware version: V1.31 - Separate LoRaWAN1.0.x Protocol version parameter to LoRaWAN1.0.3 and LoRaWAN1.0.4 - Change INIT_RX_GAIN parameter to RX_GAIN.</p> <table border="1"> <tr> <td colspan="2">Commands for PROTOCOL Parameters</td> </tr> <tr> <td>CONF:LINK:DL_DWELL_TIME</td> <td>added</td> </tr> <tr> <td>CONF:LINK:UL_DWELL_TIME</td> <td>added</td> </tr> <tr> <td colspan="2">Commands for LINK Parameters</td> </tr> <tr> <td colspan="2"> </td> </tr> <tr> <td colspan="2">Commands for POWER_MEASURE parameters</td> </tr> <tr> <td colspan="2"> </td> </tr> <tr> <td colspan="2">Commands for SENSITIVITY parameters</td> </tr> <tr> <td colspan="2"> </td> </tr> <tr> <td colspan="2">Commands for RF Parameters</td> </tr> <tr> <td>CONF:RF:RX_GAIN</td> <td>added</td> </tr> <tr> <td>READ:RF:RX_GAIN?</td> <td>added</td> </tr> <tr> <td colspan="2"> </td> </tr> <tr> <td colspan="2">Commands for NST Parameters</td> </tr> <tr> <td colspan="2"> </td> </tr> <tr> <td colspan="2"> </td> </tr> <tr> <td colspan="2">Commands for SYSTEM Parameters</td> </tr> <tr> <td colspan="2"> </td> </tr> </table>	Commands for PROTOCOL Parameters		CONF:LINK:DL_DWELL_TIME	added	CONF:LINK:UL_DWELL_TIME	added	Commands for LINK Parameters				Commands for POWER_MEASURE parameters				Commands for SENSITIVITY parameters				Commands for RF Parameters		CONF:RF:RX_GAIN	added	READ:RF:RX_GAIN?	added			Commands for NST Parameters						Commands for SYSTEM Parameters																					
Commands for PROTOCOL Parameters																																																								
CONF:LINK:DL_DWELL_TIME	added																																																							
CONF:LINK:UL_DWELL_TIME	added																																																							
Commands for LINK Parameters																																																								
Commands for POWER_MEASURE parameters																																																								
Commands for SENSITIVITY parameters																																																								
Commands for RF Parameters																																																								
CONF:RF:RX_GAIN	added																																																							
READ:RF:RX_GAIN?	added																																																							
Commands for NST Parameters																																																								
Commands for SYSTEM Parameters																																																								
V1.30	2020.08.17	<p>- Firmware version: V1.30 - Added RWC5020M information. - Added Malfunction in Link Analyzer - Updated pictures according to FW V1.30</p> <table border="1"> <tr> <td colspan="2">Commands for PROTOCOL Parameters</td> </tr> <tr> <td colspan="2"> </td> </tr> <tr> <td colspan="2">Commands for LINK Parameters</td> </tr> <tr> <td>CONF:LINK:MALFUNCTION</td> <td>added</td> </tr> <tr> <td>READ:LINK:MALFUNCTION?</td> <td>added</td> </tr> <tr> <td>CONF:LINK:MIC_ERROR</td> <td>added</td> </tr> <tr> <td>READ:LINK:MIC_ERROR?</td> <td>added</td> </tr> <tr> <td>CONF:LINK:MHDR_ERROR</td> <td>added</td> </tr> <tr> <td>READ:LINK:MHDR_ERROR?</td> <td>added</td> </tr> <tr> <td>CONF:LINK:XOR_MHDR</td> <td>added</td> </tr> <tr> <td>READ:LINK:XOR_MHDR?</td> <td>added</td> </tr> <tr> <td>CONF:LINK:FHDR_ERROR</td> <td>added</td> </tr> <tr> <td>READ:LINK:FHDR_ERROR?</td> <td>added</td> </tr> <tr> <td>CONF:LINK:XOR_FHDR</td> <td>added</td> </tr> <tr> <td>READ:LINK:XOR_FHDR?</td> <td>added</td> </tr> <tr> <td>READ:LINK:FUOTA_FILE_LEN?</td> <td>added</td> </tr> <tr> <td>READ:LINK:FUOTA_FILE_NAME?</td> <td>added</td> </tr> <tr> <td>CONF:LINK:FRAG_INDEX</td> <td>added</td> </tr> <tr> <td>CONF:LINK:FRAG_SIZE</td> <td>added</td> </tr> <tr> <td>CONF:LINK:NB_FRAG</td> <td>added</td> </tr> <tr> <td>CONF:LINK:FRAG_PADDING</td> <td>added</td> </tr> <tr> <td>CONF:LINK:FRAG_DESCRIPTOR</td> <td>added</td> </tr> <tr> <td>CONF:LINK:FRAG_ALGO</td> <td>added</td> </tr> <tr> <td>CONF:LINK:FRAG_PROGRESS</td> <td>added</td> </tr> <tr> <td>CONF:LINK:MC_KEY</td> <td>added</td> </tr> <tr> <td>CONF:LINK:MC_GROUP_ID</td> <td>added</td> </tr> <tr> <td>CONF:LINK:MC_ADDR</td> <td>added</td> </tr> </table>	Commands for PROTOCOL Parameters				Commands for LINK Parameters		CONF:LINK:MALFUNCTION	added	READ:LINK:MALFUNCTION?	added	CONF:LINK:MIC_ERROR	added	READ:LINK:MIC_ERROR?	added	CONF:LINK:MHDR_ERROR	added	READ:LINK:MHDR_ERROR?	added	CONF:LINK:XOR_MHDR	added	READ:LINK:XOR_MHDR?	added	CONF:LINK:FHDR_ERROR	added	READ:LINK:FHDR_ERROR?	added	CONF:LINK:XOR_FHDR	added	READ:LINK:XOR_FHDR?	added	READ:LINK:FUOTA_FILE_LEN?	added	READ:LINK:FUOTA_FILE_NAME?	added	CONF:LINK:FRAG_INDEX	added	CONF:LINK:FRAG_SIZE	added	CONF:LINK:NB_FRAG	added	CONF:LINK:FRAG_PADDING	added	CONF:LINK:FRAG_DESCRIPTOR	added	CONF:LINK:FRAG_ALGO	added	CONF:LINK:FRAG_PROGRESS	added	CONF:LINK:MC_KEY	added	CONF:LINK:MC_GROUP_ID	added	CONF:LINK:MC_ADDR	added
Commands for PROTOCOL Parameters																																																								
Commands for LINK Parameters																																																								
CONF:LINK:MALFUNCTION	added																																																							
READ:LINK:MALFUNCTION?	added																																																							
CONF:LINK:MIC_ERROR	added																																																							
READ:LINK:MIC_ERROR?	added																																																							
CONF:LINK:MHDR_ERROR	added																																																							
READ:LINK:MHDR_ERROR?	added																																																							
CONF:LINK:XOR_MHDR	added																																																							
READ:LINK:XOR_MHDR?	added																																																							
CONF:LINK:FHDR_ERROR	added																																																							
READ:LINK:FHDR_ERROR?	added																																																							
CONF:LINK:XOR_FHDR	added																																																							
READ:LINK:XOR_FHDR?	added																																																							
READ:LINK:FUOTA_FILE_LEN?	added																																																							
READ:LINK:FUOTA_FILE_NAME?	added																																																							
CONF:LINK:FRAG_INDEX	added																																																							
CONF:LINK:FRAG_SIZE	added																																																							
CONF:LINK:NB_FRAG	added																																																							
CONF:LINK:FRAG_PADDING	added																																																							
CONF:LINK:FRAG_DESCRIPTOR	added																																																							
CONF:LINK:FRAG_ALGO	added																																																							
CONF:LINK:FRAG_PROGRESS	added																																																							
CONF:LINK:MC_KEY	added																																																							
CONF:LINK:MC_GROUP_ID	added																																																							
CONF:LINK:MC_ADDR	added																																																							

		<table border="1"> <tr><td>CONF:LINK:MC_FREQ</td><td>added</td></tr> <tr><td>CONF:LINK:MC_DR</td><td>added</td></tr> <tr><td>CONF:LINK:MC_OPTION</td><td>added</td></tr> <tr><td>CONF:LINK:MC_INTERVAL</td><td>added</td></tr> <tr><td>CONF:LINK:FM_REBOOT_TIME_MODE</td><td>added</td></tr> <tr><td>CONF:LINK:FM_REBOOT_YEAR</td><td>added</td></tr> <tr><td>CONF:LINK:FM_REBOOT_MONTH</td><td>added</td></tr> <tr><td>CONF:LINK:FM_REBOOT_DAY</td><td>added</td></tr> <tr><td>CONF:LINK:FM_REBOOT_HOUR</td><td>added</td></tr> <tr><td>CONF:LINK:FM_REBOOT_MINUTE</td><td>added</td></tr> <tr><td>CONF:LINK:FM_REBOOT_SECOND</td><td>added</td></tr> <tr><td>CONF:LINK:FM_REBOOT_CD</td><td>added</td></tr> <tr><td>CONF:LINK:FM_NEXT_FW_VER</td><td>added</td></tr> <tr><td>CONF:LINK:FM_DEL_FW_VER</td><td>added</td></tr> <tr><td>CONF:LINK:APP_TIME_PERIOD</td><td>added</td></tr> <tr><td>CONF:LINK:APP_TIME_NB_TRANS</td><td>added</td></tr> <tr><td colspan="2">Commands for POWER_MEASURE parameters</td></tr> <tr><td colspan="2">Commands for SENSITIVITY parameters</td></tr> <tr><td colspan="2">Commands for RF Parameters</td></tr> <tr><td>CONF:RF:AS923_CH_GROUP</td><td>renamed from ...:RF:AS923_CH_MODE</td></tr> <tr><td>READ:RF:AS923_CH_GROUP?</td><td>renamed from ...:RF:AS923_CH_MODE?</td></tr> <tr><td>CONF:RF:AS923_FREQ_OFFSET</td><td>added</td></tr> <tr><td>READ:RF:AS923_FREQ_OFFSET?</td><td>added</td></tr> <tr><td>CONF:RF:CN470_CH_PLAN</td><td>added</td></tr> <tr><td>READ:RF:CN470_CH_PLAM?</td><td>added</td></tr> <tr><td colspan="2">Commands for NST Parameters</td></tr> <tr><td>CONF:NST:RX:PREAMBLE_SIZE</td><td>added</td></tr> <tr><td>READ:NST:RX:PREAMBLE_SIZE?</td><td>added</td></tr> <tr><td colspan="2">Commands for SYSTEM Parameters</td></tr> <tr><td>CONF:SYSTEM:IP_TYPE</td><td>added</td></tr> <tr><td>READ:SYSTEM:IP_TYPE?</td><td>added</td></tr> <tr><td>CONF:SYSTEM:IP_ADDR</td><td>added</td></tr> <tr><td>READ:SYSTEM:IP_ADDR?</td><td>added</td></tr> </table>	CONF:LINK:MC_FREQ	added	CONF:LINK:MC_DR	added	CONF:LINK:MC_OPTION	added	CONF:LINK:MC_INTERVAL	added	CONF:LINK:FM_REBOOT_TIME_MODE	added	CONF:LINK:FM_REBOOT_YEAR	added	CONF:LINK:FM_REBOOT_MONTH	added	CONF:LINK:FM_REBOOT_DAY	added	CONF:LINK:FM_REBOOT_HOUR	added	CONF:LINK:FM_REBOOT_MINUTE	added	CONF:LINK:FM_REBOOT_SECOND	added	CONF:LINK:FM_REBOOT_CD	added	CONF:LINK:FM_NEXT_FW_VER	added	CONF:LINK:FM_DEL_FW_VER	added	CONF:LINK:APP_TIME_PERIOD	added	CONF:LINK:APP_TIME_NB_TRANS	added	Commands for POWER_MEASURE parameters		Commands for SENSITIVITY parameters		Commands for RF Parameters		CONF:RF:AS923_CH_GROUP	renamed from ...:RF:AS923_CH_MODE	READ:RF:AS923_CH_GROUP?	renamed from ...:RF:AS923_CH_MODE?	CONF:RF:AS923_FREQ_OFFSET	added	READ:RF:AS923_FREQ_OFFSET?	added	CONF:RF:CN470_CH_PLAN	added	READ:RF:CN470_CH_PLAM?	added	Commands for NST Parameters		CONF:NST:RX:PREAMBLE_SIZE	added	READ:NST:RX:PREAMBLE_SIZE?	added	Commands for SYSTEM Parameters		CONF:SYSTEM:IP_TYPE	added	READ:SYSTEM:IP_TYPE?	added	CONF:SYSTEM:IP_ADDR	added	READ:SYSTEM:IP_ADDR?	added
CONF:LINK:MC_FREQ	added																																																																			
CONF:LINK:MC_DR	added																																																																			
CONF:LINK:MC_OPTION	added																																																																			
CONF:LINK:MC_INTERVAL	added																																																																			
CONF:LINK:FM_REBOOT_TIME_MODE	added																																																																			
CONF:LINK:FM_REBOOT_YEAR	added																																																																			
CONF:LINK:FM_REBOOT_MONTH	added																																																																			
CONF:LINK:FM_REBOOT_DAY	added																																																																			
CONF:LINK:FM_REBOOT_HOUR	added																																																																			
CONF:LINK:FM_REBOOT_MINUTE	added																																																																			
CONF:LINK:FM_REBOOT_SECOND	added																																																																			
CONF:LINK:FM_REBOOT_CD	added																																																																			
CONF:LINK:FM_NEXT_FW_VER	added																																																																			
CONF:LINK:FM_DEL_FW_VER	added																																																																			
CONF:LINK:APP_TIME_PERIOD	added																																																																			
CONF:LINK:APP_TIME_NB_TRANS	added																																																																			
Commands for POWER_MEASURE parameters																																																																				
Commands for SENSITIVITY parameters																																																																				
Commands for RF Parameters																																																																				
CONF:RF:AS923_CH_GROUP	renamed from ...:RF:AS923_CH_MODE																																																																			
READ:RF:AS923_CH_GROUP?	renamed from ...:RF:AS923_CH_MODE?																																																																			
CONF:RF:AS923_FREQ_OFFSET	added																																																																			
READ:RF:AS923_FREQ_OFFSET?	added																																																																			
CONF:RF:CN470_CH_PLAN	added																																																																			
READ:RF:CN470_CH_PLAM?	added																																																																			
Commands for NST Parameters																																																																				
CONF:NST:RX:PREAMBLE_SIZE	added																																																																			
READ:NST:RX:PREAMBLE_SIZE?	added																																																																			
Commands for SYSTEM Parameters																																																																				
CONF:SYSTEM:IP_TYPE	added																																																																			
READ:SYSTEM:IP_TYPE?	added																																																																			
CONF:SYSTEM:IP_ADDR	added																																																																			
READ:SYSTEM:IP_ADDR?	added																																																																			
V1.22	2020.05.11	<p>- Firmware version: V1.22 - Updated pictures according to FW V1.22</p> <table border="1"> <tr><td colspan="2">Commands for PROTOCOL Parameters</td></tr> <tr><td>CONF:PROTOCOL:MAC_RSP_FIELD</td><td>added</td></tr> <tr><td>READ:PROTOCOL:MAC_RSP_FIELD?</td><td>added</td></tr> <tr><td colspan="2">Commands for LINK Parameters</td></tr> <tr><td>CONF:LINK:ECHO_PAYLOAD</td><td>added</td></tr> <tr><td>READ:LINK:ECHO_PAYLOAD?</td><td>added</td></tr> <tr><td colspan="2">Commands for POWER_MEASURE parameters</td></tr> <tr><td colspan="2">Commands for SENSITIVITY parameters</td></tr> <tr><td colspan="2">Commands for RF Parameters</td></tr> <tr><td colspan="2">Commands for NST Parameters</td></tr> <tr><td>CONF:NST:TX:DUT_TYPE</td><td>deleted</td></tr> <tr><td>READ:NST:TX:DUT_TYPE?</td><td>deleted</td></tr> <tr><td>CONF:NST:RX:DUT_TYPE</td><td>deleted</td></tr> <tr><td>READ:NST:RX:DUT_TYPE?</td><td>deleted</td></tr> <tr><td>CONF:NST:MFG:DUT_TYPE</td><td>deleted</td></tr> <tr><td>READ:NST:MFG:DUT_TYPE?</td><td>deleted</td></tr> <tr><td>CONF:PROTOCOL:DUT_TYPE</td><td>deleted</td></tr> <tr><td>READ:PROTOCOL:DUT_TYPE?</td><td>deleted</td></tr> </table>	Commands for PROTOCOL Parameters		CONF:PROTOCOL:MAC_RSP_FIELD	added	READ:PROTOCOL:MAC_RSP_FIELD?	added	Commands for LINK Parameters		CONF:LINK:ECHO_PAYLOAD	added	READ:LINK:ECHO_PAYLOAD?	added	Commands for POWER_MEASURE parameters		Commands for SENSITIVITY parameters		Commands for RF Parameters		Commands for NST Parameters		CONF:NST:TX:DUT_TYPE	deleted	READ:NST:TX:DUT_TYPE?	deleted	CONF:NST:RX:DUT_TYPE	deleted	READ:NST:RX:DUT_TYPE?	deleted	CONF:NST:MFG:DUT_TYPE	deleted	READ:NST:MFG:DUT_TYPE?	deleted	CONF:PROTOCOL:DUT_TYPE	deleted	READ:PROTOCOL:DUT_TYPE?	deleted																														
Commands for PROTOCOL Parameters																																																																				
CONF:PROTOCOL:MAC_RSP_FIELD	added																																																																			
READ:PROTOCOL:MAC_RSP_FIELD?	added																																																																			
Commands for LINK Parameters																																																																				
CONF:LINK:ECHO_PAYLOAD	added																																																																			
READ:LINK:ECHO_PAYLOAD?	added																																																																			
Commands for POWER_MEASURE parameters																																																																				
Commands for SENSITIVITY parameters																																																																				
Commands for RF Parameters																																																																				
Commands for NST Parameters																																																																				
CONF:NST:TX:DUT_TYPE	deleted																																																																			
READ:NST:TX:DUT_TYPE?	deleted																																																																			
CONF:NST:RX:DUT_TYPE	deleted																																																																			
READ:NST:RX:DUT_TYPE?	deleted																																																																			
CONF:NST:MFG:DUT_TYPE	deleted																																																																			
READ:NST:MFG:DUT_TYPE?	deleted																																																																			
CONF:PROTOCOL:DUT_TYPE	deleted																																																																			
READ:PROTOCOL:DUT_TYPE?	deleted																																																																			

V1.21	2019.12.30	<p>- Firmware version: V1.21 - Updated pictures according to FW V1.21</p> <table border="1" data-bbox="539 407 1452 1012"> <tr><td colspan="2">Commands for PROTOCOL Parameters</td></tr> <tr><td colspan="2"> </td></tr> <tr><td colspan="2">Commands for LINK Parameters</td></tr> <tr><td>READ:LINK:STATUS?</td><td>added</td></tr> <tr><td colspan="2"> </td></tr> <tr><td colspan="2">Commands for POWER MEASURE parameters</td></tr> <tr><td colspan="2"> </td></tr> <tr><td colspan="2">Commands for SENSITIVITY parameters</td></tr> <tr><td colspan="2"> </td></tr> <tr><td colspan="2">Commands for RF Parameters</td></tr> <tr><td>CONF:RF:PING_FREQ</td><td>added</td></tr> <tr><td>CONF:RF:PING_DR</td><td>added</td></tr> <tr><td>CONF:RF:BEACON_FREQ</td><td>added</td></tr> <tr><td>CONF:RF:BEACON_FREQ</td><td>added</td></tr> <tr><td>CONF:RF:TX_FREQ</td><td>added</td></tr> <tr><td>READ:RF:TX_FREQ?</td><td>added</td></tr> <tr><td>CONF:RF:RX_FREQ</td><td>added</td></tr> <tr><td>READ:RF:RX_FREQ?</td><td>added</td></tr> <tr><td>CONF:RF:MFG_FREQ</td><td>added</td></tr> <tr><td>READ:RF:MFG_FREQ?</td><td>added</td></tr> <tr><td colspan="2">Commands for NST Parameters</td></tr> <tr><td>CONF:NST:RX:CR</td><td>added</td></tr> <tr><td>READ:NST:RX:CR?</td><td>added</td></tr> </table>	Commands for PROTOCOL Parameters				Commands for LINK Parameters		READ:LINK:STATUS?	added			Commands for POWER MEASURE parameters				Commands for SENSITIVITY parameters				Commands for RF Parameters		CONF:RF:PING_FREQ	added	CONF:RF:PING_DR	added	CONF:RF:BEACON_FREQ	added	CONF:RF:BEACON_FREQ	added	CONF:RF:TX_FREQ	added	READ:RF:TX_FREQ?	added	CONF:RF:RX_FREQ	added	READ:RF:RX_FREQ?	added	CONF:RF:MFG_FREQ	added	READ:RF:MFG_FREQ?	added	Commands for NST Parameters		CONF:NST:RX:CR	added	READ:NST:RX:CR?	added																
Commands for PROTOCOL Parameters																																																																
Commands for LINK Parameters																																																																
READ:LINK:STATUS?	added																																																															
Commands for POWER MEASURE parameters																																																																
Commands for SENSITIVITY parameters																																																																
Commands for RF Parameters																																																																
CONF:RF:PING_FREQ	added																																																															
CONF:RF:PING_DR	added																																																															
CONF:RF:BEACON_FREQ	added																																																															
CONF:RF:BEACON_FREQ	added																																																															
CONF:RF:TX_FREQ	added																																																															
READ:RF:TX_FREQ?	added																																																															
CONF:RF:RX_FREQ	added																																																															
READ:RF:RX_FREQ?	added																																																															
CONF:RF:MFG_FREQ	added																																																															
READ:RF:MFG_FREQ?	added																																																															
Commands for NST Parameters																																																																
CONF:NST:RX:CR	added																																																															
READ:NST:RX:CR?	added																																																															
V1.20	2019.09.16	<p>- Firmware version: V1.20 - Add RWC5020B features and RF specification - Updated pictures according to FW V1.20</p> <table border="1" data-bbox="539 1198 1452 1998"> <tr><td colspan="2">Commands for PROTOCOL Parameters</td></tr> <tr><td>CONF:PROTOCOL:MAC_FORMAT</td><td>deleted</td></tr> <tr><td>READ:PROTOCOL:MAC_FORMAT?</td><td>deleted</td></tr> <tr><td>CONF:PROTOCOL:FCNT</td><td>deleted</td></tr> <tr><td>READ:PROTOCOL:FCNT?</td><td>deleted</td></tr> <tr><td>CONF:PROTOCOL:FCNT_MODE</td><td>deleted</td></tr> <tr><td>READ:PROTOCOL:FCNT_MODE?</td><td>deleted</td></tr> <tr><td>CONF:PROTOCOL:ADR_ACK_REQ</td><td>deleted</td></tr> <tr><td>READ:PROTOCOL:ADR_ACK_REQ?</td><td>deleted</td></tr> <tr><td>CONF:PROTOCOL:ACK</td><td>deleted</td></tr> <tr><td>READ:PROTOCOL:ACK?</td><td>deleted</td></tr> <tr><td>CONF:PROTOCOL:FPENDING</td><td>deleted</td></tr> <tr><td>READ:PROTOCOL:FPENDING?</td><td>deleted</td></tr> <tr><td colspan="2">Commands for LINK Parameters</td></tr> <tr><td>CONF:LINK:ADR_CH_MASK_OPT</td><td>added</td></tr> <tr><td>READ:LINK:ADR_CH_MASK_OPT?</td><td>added</td></tr> <tr><td>READ:LINK:DUTY_CYCLE?</td><td>added</td></tr> <tr><td colspan="2">Commands for POWER MEASURE parameters</td></tr> <tr><td>CONF:POWER:TARGET_CH_MASK_OPT</td><td>added</td></tr> <tr><td>READ:POWER:TARGET_CH_MASK_OPT?</td><td>added</td></tr> <tr><td colspan="2">Commands for SENSITIVITY parameters</td></tr> <tr><td>CONF:SENSITIVITY:TARGET_CH_MASK_OPT</td><td>added</td></tr> <tr><td>READ:SENSITIVITY:TARGET_CH_MASK_OPT?</td><td>added</td></tr> <tr><td colspan="2">Commands for RF Parameters</td></tr> <tr><td>READ:RF:MEASURED_FREQ?</td><td>added</td></tr> <tr><td>READ:RF:MEASURED_FREQ_MAX?</td><td>added</td></tr> <tr><td>READ:RF:MEASURED_FREQ_AVG?</td><td>added</td></tr> <tr><td>READ:RF:MEASURED_FREQ_MIN?</td><td>added</td></tr> <tr><td>CONF:RF:AS923_CH_MODE</td><td>added</td></tr> <tr><td>READ:RF:AS923_CH_MODE?</td><td>added</td></tr> <tr><td>CONF:RF:SYSCLK_OFFSET</td><td>added</td></tr> </table>	Commands for PROTOCOL Parameters		CONF:PROTOCOL:MAC_FORMAT	deleted	READ:PROTOCOL:MAC_FORMAT?	deleted	CONF:PROTOCOL:FCNT	deleted	READ:PROTOCOL:FCNT?	deleted	CONF:PROTOCOL:FCNT_MODE	deleted	READ:PROTOCOL:FCNT_MODE?	deleted	CONF:PROTOCOL:ADR_ACK_REQ	deleted	READ:PROTOCOL:ADR_ACK_REQ?	deleted	CONF:PROTOCOL:ACK	deleted	READ:PROTOCOL:ACK?	deleted	CONF:PROTOCOL:FPENDING	deleted	READ:PROTOCOL:FPENDING?	deleted	Commands for LINK Parameters		CONF:LINK:ADR_CH_MASK_OPT	added	READ:LINK:ADR_CH_MASK_OPT?	added	READ:LINK:DUTY_CYCLE?	added	Commands for POWER MEASURE parameters		CONF:POWER:TARGET_CH_MASK_OPT	added	READ:POWER:TARGET_CH_MASK_OPT?	added	Commands for SENSITIVITY parameters		CONF:SENSITIVITY:TARGET_CH_MASK_OPT	added	READ:SENSITIVITY:TARGET_CH_MASK_OPT?	added	Commands for RF Parameters		READ:RF:MEASURED_FREQ?	added	READ:RF:MEASURED_FREQ_MAX?	added	READ:RF:MEASURED_FREQ_AVG?	added	READ:RF:MEASURED_FREQ_MIN?	added	CONF:RF:AS923_CH_MODE	added	READ:RF:AS923_CH_MODE?	added	CONF:RF:SYSCLK_OFFSET	added
Commands for PROTOCOL Parameters																																																																
CONF:PROTOCOL:MAC_FORMAT	deleted																																																															
READ:PROTOCOL:MAC_FORMAT?	deleted																																																															
CONF:PROTOCOL:FCNT	deleted																																																															
READ:PROTOCOL:FCNT?	deleted																																																															
CONF:PROTOCOL:FCNT_MODE	deleted																																																															
READ:PROTOCOL:FCNT_MODE?	deleted																																																															
CONF:PROTOCOL:ADR_ACK_REQ	deleted																																																															
READ:PROTOCOL:ADR_ACK_REQ?	deleted																																																															
CONF:PROTOCOL:ACK	deleted																																																															
READ:PROTOCOL:ACK?	deleted																																																															
CONF:PROTOCOL:FPENDING	deleted																																																															
READ:PROTOCOL:FPENDING?	deleted																																																															
Commands for LINK Parameters																																																																
CONF:LINK:ADR_CH_MASK_OPT	added																																																															
READ:LINK:ADR_CH_MASK_OPT?	added																																																															
READ:LINK:DUTY_CYCLE?	added																																																															
Commands for POWER MEASURE parameters																																																																
CONF:POWER:TARGET_CH_MASK_OPT	added																																																															
READ:POWER:TARGET_CH_MASK_OPT?	added																																																															
Commands for SENSITIVITY parameters																																																																
CONF:SENSITIVITY:TARGET_CH_MASK_OPT	added																																																															
READ:SENSITIVITY:TARGET_CH_MASK_OPT?	added																																																															
Commands for RF Parameters																																																																
READ:RF:MEASURED_FREQ?	added																																																															
READ:RF:MEASURED_FREQ_MAX?	added																																																															
READ:RF:MEASURED_FREQ_AVG?	added																																																															
READ:RF:MEASURED_FREQ_MIN?	added																																																															
CONF:RF:AS923_CH_MODE	added																																																															
READ:RF:AS923_CH_MODE?	added																																																															
CONF:RF:SYSCLK_OFFSET	added																																																															

		<table border="1"> <tr><td>READ:RF:SYSCLK_OFFSET?</td><td>added</td></tr> <tr><td colspan="2">Commands for NST Parameters</td></tr> <tr><td>EXEC:NST:TX:CLEAR</td><td>added</td></tr> <tr><td>EXEC:NST:RX:CLEAR</td><td>added</td></tr> <tr><td>READ:NST:TX:STATUS?</td><td>added</td></tr> <tr><td>READ:NST:RX:CW_POW?</td><td>added</td></tr> <tr><td>READ:NST:RX:CW_FREQ?</td><td>added</td></tr> <tr><td>CONF:NST:MFG:PAYLOAD</td><td>added</td></tr> <tr><td>READ:NST:MFG:PAYLOAD?</td><td>added</td></tr> </table>	READ:RF:SYSCLK_OFFSET?	added	Commands for NST Parameters		EXEC:NST:TX:CLEAR	added	EXEC:NST:RX:CLEAR	added	READ:NST:TX:STATUS?	added	READ:NST:RX:CW_POW?	added	READ:NST:RX:CW_FREQ?	added	CONF:NST:MFG:PAYLOAD	added	READ:NST:MFG:PAYLOAD?	added																																																																										
READ:RF:SYSCLK_OFFSET?	added																																																																																													
Commands for NST Parameters																																																																																														
EXEC:NST:TX:CLEAR	added																																																																																													
EXEC:NST:RX:CLEAR	added																																																																																													
READ:NST:TX:STATUS?	added																																																																																													
READ:NST:RX:CW_POW?	added																																																																																													
READ:NST:RX:CW_FREQ?	added																																																																																													
CONF:NST:MFG:PAYLOAD	added																																																																																													
READ:NST:MFG:PAYLOAD?	added																																																																																													
V1.17	2019.06.14	<ul style="list-style-type: none"> - Firmware version: V1.17 - Updated pictures according to FW V1.17 - Combine POW_TIME and POW_CH submenus into POW_MEASURE - Added TX Power measure function using specified scenario - In Power Measure, MODE, SCENARIO, ADR_POWER, UL_DR, TARGET_CH_MASK, PKT_NUM, CW_TIMEOUT, CW_FREQ, CW_POW parameters are added - TARGET_CH_MASK parameter is added for GWT sensitivity test <table border="1"> <tr><td colspan="2">Commands for PROTOCOL Parameters</td></tr> <tr><td>CONF:PROTOCOL:MAC_RSP_SLOT</td><td>added</td></tr> <tr><td>READ:PROTOCOL:MAC_RSP_SLOT?</td><td>added</td></tr> <tr><td colspan="2">Commands for LINK Parameters</td></tr> <tr><td>CONF:LINK:RX2_FREQ</td><td>added</td></tr> <tr><td>READ:LINK:RX2_FREQ?</td><td>added</td></tr> <tr><td>CONF:LINK:RX2_DR</td><td>added</td></tr> <tr><td>READ:LINK:RX2_DR?</td><td>added</td></tr> <tr><td>CONF:LINK:RECEIVE_DELAY</td><td>added</td></tr> <tr><td>READ:LINK:RECEIVE_DELAY?</td><td>added</td></tr> <tr><td>CONF:LINK:RX1_DR_OFFSET</td><td>added</td></tr> <tr><td>READ:LINK:RX1_DR_OFFSET?</td><td>added</td></tr> <tr><td>CONF:LINK:ABNORMAL</td><td>added</td></tr> <tr><td>READ:LINK:ABNORMAL?</td><td>added</td></tr> <tr><td>CONF:LINK:BEACON_DR</td><td>deleted</td></tr> <tr><td>READ:LINK:BEACON_DR?</td><td>deleted</td></tr> <tr><td colspan="2">Commands for POWER_MEASURE parameters</td></tr> <tr><td>CONF:POWER:TARGET_CH_MASK</td><td>added</td></tr> <tr><td>READ:POWER:TARGET_CH_MASK?</td><td>added</td></tr> <tr><td>EXEC:POWER:RUN</td><td>added</td></tr> <tr><td>EXEC:POWER:STOP</td><td>added</td></tr> <tr><td>CONF:POWER:MODE</td><td>added</td></tr> <tr><td>READ:POWER:MODE?</td><td>added</td></tr> <tr><td>CONF:POWER:SCENARIO</td><td>added</td></tr> <tr><td>READ:POWER:SCENARIO?</td><td>added</td></tr> <tr><td>CONF:POWER:ADR_POWER</td><td>added</td></tr> <tr><td>READ:POWER:ADR_POWER?</td><td>added</td></tr> <tr><td>CONF:POWER:UL_DR</td><td>added</td></tr> <tr><td>READ:POWER:UL_DR?</td><td>added</td></tr> <tr><td>CONF:POWER:PKT_NUM</td><td>added</td></tr> <tr><td>READ:POWER:PKT_NUM?</td><td>added</td></tr> <tr><td>CONF:POWER:CW_TIMEOUT</td><td>added</td></tr> <tr><td>READ:POWER:CW_TIMEOUT?</td><td>added</td></tr> <tr><td>CONF:POWER:CW_FREQ</td><td>added</td></tr> <tr><td>READ:POWER:CW_FREQ?</td><td>added</td></tr> <tr><td>CONF:POWER:CW_POW</td><td>added</td></tr> <tr><td>READ:POWER:CW_POW?</td><td>added</td></tr> <tr><td colspan="2">Commands for SENSITIVITY parameters</td></tr> <tr><td>CONF:SENSITIVITY:TARGET_DL_CH</td><td>added</td></tr> <tr><td>READ:SENSITIVITY:TARGET_DL_CH?</td><td>added</td></tr> <tr><td colspan="2">Commands for RF Parameters</td></tr> <tr><td>READ:RF:PING_FREQ?</td><td>added</td></tr> <tr><td>READ:RF:PING_DR?</td><td>added</td></tr> <tr><td>READ:RF:BEACON_FREQ?</td><td>added</td></tr> <tr><td>READ:RF:BEACON_DR?</td><td>added</td></tr> <tr><td colspan="2">Commands for NST Parameters</td></tr> </table>	Commands for PROTOCOL Parameters		CONF:PROTOCOL:MAC_RSP_SLOT	added	READ:PROTOCOL:MAC_RSP_SLOT?	added	Commands for LINK Parameters		CONF:LINK:RX2_FREQ	added	READ:LINK:RX2_FREQ?	added	CONF:LINK:RX2_DR	added	READ:LINK:RX2_DR?	added	CONF:LINK:RECEIVE_DELAY	added	READ:LINK:RECEIVE_DELAY?	added	CONF:LINK:RX1_DR_OFFSET	added	READ:LINK:RX1_DR_OFFSET?	added	CONF:LINK:ABNORMAL	added	READ:LINK:ABNORMAL?	added	CONF:LINK:BEACON_DR	deleted	READ:LINK:BEACON_DR?	deleted	Commands for POWER_MEASURE parameters		CONF:POWER:TARGET_CH_MASK	added	READ:POWER:TARGET_CH_MASK?	added	EXEC:POWER:RUN	added	EXEC:POWER:STOP	added	CONF:POWER:MODE	added	READ:POWER:MODE?	added	CONF:POWER:SCENARIO	added	READ:POWER:SCENARIO?	added	CONF:POWER:ADR_POWER	added	READ:POWER:ADR_POWER?	added	CONF:POWER:UL_DR	added	READ:POWER:UL_DR?	added	CONF:POWER:PKT_NUM	added	READ:POWER:PKT_NUM?	added	CONF:POWER:CW_TIMEOUT	added	READ:POWER:CW_TIMEOUT?	added	CONF:POWER:CW_FREQ	added	READ:POWER:CW_FREQ?	added	CONF:POWER:CW_POW	added	READ:POWER:CW_POW?	added	Commands for SENSITIVITY parameters		CONF:SENSITIVITY:TARGET_DL_CH	added	READ:SENSITIVITY:TARGET_DL_CH?	added	Commands for RF Parameters		READ:RF:PING_FREQ?	added	READ:RF:PING_DR?	added	READ:RF:BEACON_FREQ?	added	READ:RF:BEACON_DR?	added	Commands for NST Parameters	
Commands for PROTOCOL Parameters																																																																																														
CONF:PROTOCOL:MAC_RSP_SLOT	added																																																																																													
READ:PROTOCOL:MAC_RSP_SLOT?	added																																																																																													
Commands for LINK Parameters																																																																																														
CONF:LINK:RX2_FREQ	added																																																																																													
READ:LINK:RX2_FREQ?	added																																																																																													
CONF:LINK:RX2_DR	added																																																																																													
READ:LINK:RX2_DR?	added																																																																																													
CONF:LINK:RECEIVE_DELAY	added																																																																																													
READ:LINK:RECEIVE_DELAY?	added																																																																																													
CONF:LINK:RX1_DR_OFFSET	added																																																																																													
READ:LINK:RX1_DR_OFFSET?	added																																																																																													
CONF:LINK:ABNORMAL	added																																																																																													
READ:LINK:ABNORMAL?	added																																																																																													
CONF:LINK:BEACON_DR	deleted																																																																																													
READ:LINK:BEACON_DR?	deleted																																																																																													
Commands for POWER_MEASURE parameters																																																																																														
CONF:POWER:TARGET_CH_MASK	added																																																																																													
READ:POWER:TARGET_CH_MASK?	added																																																																																													
EXEC:POWER:RUN	added																																																																																													
EXEC:POWER:STOP	added																																																																																													
CONF:POWER:MODE	added																																																																																													
READ:POWER:MODE?	added																																																																																													
CONF:POWER:SCENARIO	added																																																																																													
READ:POWER:SCENARIO?	added																																																																																													
CONF:POWER:ADR_POWER	added																																																																																													
READ:POWER:ADR_POWER?	added																																																																																													
CONF:POWER:UL_DR	added																																																																																													
READ:POWER:UL_DR?	added																																																																																													
CONF:POWER:PKT_NUM	added																																																																																													
READ:POWER:PKT_NUM?	added																																																																																													
CONF:POWER:CW_TIMEOUT	added																																																																																													
READ:POWER:CW_TIMEOUT?	added																																																																																													
CONF:POWER:CW_FREQ	added																																																																																													
READ:POWER:CW_FREQ?	added																																																																																													
CONF:POWER:CW_POW	added																																																																																													
READ:POWER:CW_POW?	added																																																																																													
Commands for SENSITIVITY parameters																																																																																														
CONF:SENSITIVITY:TARGET_DL_CH	added																																																																																													
READ:SENSITIVITY:TARGET_DL_CH?	added																																																																																													
Commands for RF Parameters																																																																																														
READ:RF:PING_FREQ?	added																																																																																													
READ:RF:PING_DR?	added																																																																																													
READ:RF:BEACON_FREQ?	added																																																																																													
READ:RF:BEACON_DR?	added																																																																																													
Commands for NST Parameters																																																																																														

V1.16	2019.04.12	<ul style="list-style-type: none"> - Firmware version: V1.16 - Updated all pictures according to FW V1.16 - Add FOPTS_SIZE and FOPTS parameters - Remove PAYLOAD_TYPE parameter from User defined MAC command <table border="1" style="width: 100%; border-collapse: collapse;"> <tr> <th colspan="2" style="background-color: #e1eef6;">Commands for PROTOCOL Parameters</th> </tr> <tr> <td>CONF:PROTOCOL:MAC_RSP_SLOT</td> <td>added</td> </tr> <tr> <td>READ:PROTOCOL:MAC_RSP_SLOT?</td> <td>added</td> </tr> <tr> <th colspan="2" style="background-color: #e1eef6;">Commands for LINK Parameters</th> </tr> <tr> <td>CONF:LINK:FOPTS_SIZE</td> <td>added</td> </tr> <tr> <td>READ:LINK:FOPTS_SIZE?</td> <td>added</td> </tr> <tr> <td>CONF:LINK:FOPTS</td> <td>added</td> </tr> <tr> <td>READ:LINK:FOPTS?</td> <td>added</td> </tr> <tr> <td>CONF:LINK:MAC_ANS_TO</td> <td>added</td> </tr> <tr> <td>READ:LINK:MAC_ANS_TO?</td> <td>added</td> </tr> <tr> <td>EXEC:LINK:MSG_RESET</td> <td>added</td> </tr> <tr> <td>READ:LINK:MSG?</td> <td>added</td> </tr> <tr> <td>CONF:LINK:PAYLOAD_TYPE</td> <td>deleted</td> </tr> <tr> <td>READ:LINK:PAYLOAD_TYPE?</td> <td>deleted</td> </tr> <tr> <th colspan="2" style="background-color: #e1eef6;">Commands for SENSITIVITY parameters</th> </tr> <tr> <td> </td> <td> </td> </tr> <tr> <th colspan="2" style="background-color: #e1eef6;">Commands for RF Parameters</th> </tr> <tr> <td> </td> <td> </td> </tr> <tr> <th colspan="2" style="background-color: #e1eef6;">Commands for NST Parameters</th> </tr> <tr> <td> </td> <td> </td> </tr> </table>	Commands for PROTOCOL Parameters		CONF:PROTOCOL:MAC_RSP_SLOT	added	READ:PROTOCOL:MAC_RSP_SLOT?	added	Commands for LINK Parameters		CONF:LINK:FOPTS_SIZE	added	READ:LINK:FOPTS_SIZE?	added	CONF:LINK:FOPTS	added	READ:LINK:FOPTS?	added	CONF:LINK:MAC_ANS_TO	added	READ:LINK:MAC_ANS_TO?	added	EXEC:LINK:MSG_RESET	added	READ:LINK:MSG?	added	CONF:LINK:PAYLOAD_TYPE	deleted	READ:LINK:PAYLOAD_TYPE?	deleted	Commands for SENSITIVITY parameters				Commands for RF Parameters				Commands for NST Parameters			
Commands for PROTOCOL Parameters																																										
CONF:PROTOCOL:MAC_RSP_SLOT	added																																									
READ:PROTOCOL:MAC_RSP_SLOT?	added																																									
Commands for LINK Parameters																																										
CONF:LINK:FOPTS_SIZE	added																																									
READ:LINK:FOPTS_SIZE?	added																																									
CONF:LINK:FOPTS	added																																									
READ:LINK:FOPTS?	added																																									
CONF:LINK:MAC_ANS_TO	added																																									
READ:LINK:MAC_ANS_TO?	added																																									
EXEC:LINK:MSG_RESET	added																																									
READ:LINK:MSG?	added																																									
CONF:LINK:PAYLOAD_TYPE	deleted																																									
READ:LINK:PAYLOAD_TYPE?	deleted																																									
Commands for SENSITIVITY parameters																																										
Commands for RF Parameters																																										
Commands for NST Parameters																																										
V1.15	2018.12.14	<ul style="list-style-type: none"> - Firmware version: V1.15 - Updated all pictures according to FW V1.15 - Some Remote command requires more parameters like MAC command index number for multi MAC function. Add this information for multi parameter remote command. <table border="1" style="width: 100%; border-collapse: collapse;"> <tr> <th colspan="2" style="background-color: #e1eef6;">Commands for PROTOCOL Parameters</th> </tr> <tr> <td>CONF:PROTOCOL:PING_TIME_OFFSET</td> <td>added</td> </tr> <tr> <td>READ:PROTOCOL:PING_TIME_OFFSET?</td> <td>added</td> </tr> <tr> <th colspan="2" style="background-color: #e1eef6;">Commands for LINK Parameters</th> </tr> <tr> <td>CONF:LINK:MAC_INTERVAL</td> <td>added</td> </tr> <tr> <td>READ:LINK:MAC_INTERVAL?</td> <td>added</td> </tr> <tr> <td>READ:LINK:MAC_SEND_STATUS?</td> <td>added</td> </tr> <tr> <td>READ:LINK:MAC_SEND_RESULT?</td> <td>added</td> </tr> <tr> <th colspan="2" style="background-color: #e1eef6;">Commands for SENSITIVITY parameters</th> </tr> <tr> <td> </td> <td> </td> </tr> <tr> <th colspan="2" style="background-color: #e1eef6;">Commands for RF Parameters</th> </tr> <tr> <td> </td> <td> </td> </tr> <tr> <th colspan="2" style="background-color: #e1eef6;">Commands for NST Parameters</th> </tr> <tr> <td> </td> <td> </td> </tr> </table>	Commands for PROTOCOL Parameters		CONF:PROTOCOL:PING_TIME_OFFSET	added	READ:PROTOCOL:PING_TIME_OFFSET?	added	Commands for LINK Parameters		CONF:LINK:MAC_INTERVAL	added	READ:LINK:MAC_INTERVAL?	added	READ:LINK:MAC_SEND_STATUS?	added	READ:LINK:MAC_SEND_RESULT?	added	Commands for SENSITIVITY parameters				Commands for RF Parameters				Commands for NST Parameters															
Commands for PROTOCOL Parameters																																										
CONF:PROTOCOL:PING_TIME_OFFSET	added																																									
READ:PROTOCOL:PING_TIME_OFFSET?	added																																									
Commands for LINK Parameters																																										
CONF:LINK:MAC_INTERVAL	added																																									
READ:LINK:MAC_INTERVAL?	added																																									
READ:LINK:MAC_SEND_STATUS?	added																																									
READ:LINK:MAC_SEND_RESULT?	added																																									
Commands for SENSITIVITY parameters																																										
Commands for RF Parameters																																										
Commands for NST Parameters																																										
V1.14	2018.10.10	<ul style="list-style-type: none"> - Firmware version: V1.14 - Updated all pictures according to FW V1.14 - Change the abbreviation of Region name AU921 <input type="checkbox"/> AU915, CN490 <input type="checkbox"/> CN470, KR922 <input type="checkbox"/> KR920, IN866 <input type="checkbox"/> IN865, RU867 <input type="checkbox"/> RU864 - Added Any Data Rate type for NST RX and MFG in NST mode - Added or renamed remote commands. See 4.4 for details. <table border="1" style="width: 100%; border-collapse: collapse;"> <tr> <th colspan="2" style="background-color: #e1eef6;">Commands for PROTOCOL Parameters</th> </tr> <tr> <td>CONF:PROTOCOL:NWK_ID</td> <td>added</td> </tr> <tr> <td>READ:PROTOCOL:NWK_ID?</td> <td>added</td> </tr> </table>	Commands for PROTOCOL Parameters		CONF:PROTOCOL:NWK_ID	added	READ:PROTOCOL:NWK_ID?	added																																		
Commands for PROTOCOL Parameters																																										
CONF:PROTOCOL:NWK_ID	added																																									
READ:PROTOCOL:NWK_ID?	added																																									

		<table border="1"> <tr> <td>CONF:PROTOCOL:NET_ID_MSB READ:PROTOCOL:NET_ID_MSB?</td> <td>added added</td> </tr> <tr> <td>CONF:PROTOCOL:NWK_ADDR READ:PROTOCOL:NWK_ADDR?</td> <td>added added</td> </tr> <tr> <td>CONF:PROTOCOL:BEACON_TIME_OFFSET READ:PROTOCOL:BEACON_TIME_OFFSET?</td> <td>added added</td> </tr> <tr> <td colspan="2">Commands for LINK Parameters</td> </tr> <tr> <td colspan="2">Commands for SENSITIVITY parameters</td> </tr> <tr> <td>CONF:SENSITIVITY:TARGET_CH_MASK READ:SENSITIVITY:TARGET_CH_MASK?</td> <td>added added</td> </tr> <tr> <td>CONF:SENSITIVITY:TARGET_DR READ:SENSITIVITY:TARGET_DR?</td> <td>renamed from ...:SF renamed from ...:SF?</td> </tr> <tr> <td colspan="2">Commands for RF Parameters</td> </tr> <tr> <td colspan="2">Commands for NST Parameters</td> </tr> <tr> <td>CONF:NST:TX:FM_DEVIATION READ:NST:TX:FM_DEVIATION?</td> <td>added added</td> </tr> <tr> <td>CONF:NST:MFG:FM_DEVIATION READ:NST:MFG:FM_DEVIATION?</td> <td>added added</td> </tr> <tr> <td>CONF:NST:TX:DATA_RATE READ:NST:TX:DATA_RATE?</td> <td>added added</td> </tr> <tr> <td>CONF:NST:RX:DATA_RATE READ:NST:RX:DATA_RATE?</td> <td>added added</td> </tr> <tr> <td>CONF:NST:MFG:DATA_RATE READ:NST:MFG:DATA_RATE?</td> <td>added added</td> </tr> <tr> <td>CONF:NST:TX:SYNC_WORD_SIZE READ:NST:TX:SYNC_WORD_SIZE?</td> <td>added added</td> </tr> <tr> <td>CONF:NST:RX:SYNC_WORD_SIZE READ:NST:RX:SYNC_WORD_SIZE?</td> <td>added added</td> </tr> <tr> <td>CONF:NST:MFG:SYNC_WORD_SIZE READ:NST:MFG:SYNC_WORD_SIZE?</td> <td>added added</td> </tr> <tr> <td>CONF:NST:TX:SYNC_WORD READ:NST:TX:SYNC_WORD?</td> <td>added added</td> </tr> <tr> <td>CONF:NST:RX:SYNC_WORD READ:NST:RX:SYNC_WORD?</td> <td>added added</td> </tr> <tr> <td>CONF:NST:MFG:SYNC_WORD READ:NST:MFG:SYNC_WORD?</td> <td>added added</td> </tr> <tr> <td>CONF:NST:TX:MODULATION READ:NST:TX:MODULATION?</td> <td>renamed from ...:MODE renamed from ...:MODE?</td> </tr> <tr> <td>CONF:NST:RX:MODULATION READ:NST:RX:MODULATION?</td> <td>added added</td> </tr> <tr> <td>CONF:NST:MFG:MODULATION READ:NST:MFG:MODULATION?</td> <td>added added</td> </tr> <tr> <td>CONF:NST:TX:DUT_TYPE READ:NST:TX:DUT_TYPE?</td> <td>renamed from ...:PROTOCOL:DUT_TYPE renamed from ...:PROTOCOL:DUT_TYPE?</td> </tr> <tr> <td>CONF:NST:RX:DUT_TYPE READ:NST:RX:DUT_TYPE?</td> <td>added added</td> </tr> <tr> <td>CONF:NST:MFG:DUT_TYPE READ:NST:MFG:DUT_TYPE?</td> <td>added added</td> </tr> <tr> <td>CONF:NST:TX:TX_POLARITY READ:NST:TX:TX_POLARITY?</td> <td>added added</td> </tr> <tr> <td>CONF:NST:RX:RX_POLARITY READ:NST:RX:RX_POLARITY?</td> <td>added added</td> </tr> <tr> <td>CONF:NST:MFG:TX_POLARITY READ:NST:MFG:TX_POLARITY?</td> <td>added added</td> </tr> <tr> <td>CONF:NST:MFG:RX_POLARITY READ:NST:MFG:RX_POLARITY?</td> <td>added added</td> </tr> </table>	CONF:PROTOCOL:NET_ID_MSB READ:PROTOCOL:NET_ID_MSB?	added added	CONF:PROTOCOL:NWK_ADDR READ:PROTOCOL:NWK_ADDR?	added added	CONF:PROTOCOL:BEACON_TIME_OFFSET READ:PROTOCOL:BEACON_TIME_OFFSET?	added added	Commands for LINK Parameters		Commands for SENSITIVITY parameters		CONF:SENSITIVITY:TARGET_CH_MASK READ:SENSITIVITY:TARGET_CH_MASK?	added added	CONF:SENSITIVITY:TARGET_DR READ:SENSITIVITY:TARGET_DR?	renamed from ...:SF renamed from ...:SF?	Commands for RF Parameters		Commands for NST Parameters		CONF:NST:TX:FM_DEVIATION READ:NST:TX:FM_DEVIATION?	added added	CONF:NST:MFG:FM_DEVIATION READ:NST:MFG:FM_DEVIATION?	added added	CONF:NST:TX:DATA_RATE READ:NST:TX:DATA_RATE?	added added	CONF:NST:RX:DATA_RATE READ:NST:RX:DATA_RATE?	added added	CONF:NST:MFG:DATA_RATE READ:NST:MFG:DATA_RATE?	added added	CONF:NST:TX:SYNC_WORD_SIZE READ:NST:TX:SYNC_WORD_SIZE?	added added	CONF:NST:RX:SYNC_WORD_SIZE READ:NST:RX:SYNC_WORD_SIZE?	added added	CONF:NST:MFG:SYNC_WORD_SIZE READ:NST:MFG:SYNC_WORD_SIZE?	added added	CONF:NST:TX:SYNC_WORD READ:NST:TX:SYNC_WORD?	added added	CONF:NST:RX:SYNC_WORD READ:NST:RX:SYNC_WORD?	added added	CONF:NST:MFG:SYNC_WORD READ:NST:MFG:SYNC_WORD?	added added	CONF:NST:TX:MODULATION READ:NST:TX:MODULATION?	renamed from ...:MODE renamed from ...:MODE?	CONF:NST:RX:MODULATION READ:NST:RX:MODULATION?	added added	CONF:NST:MFG:MODULATION READ:NST:MFG:MODULATION?	added added	CONF:NST:TX:DUT_TYPE READ:NST:TX:DUT_TYPE?	renamed from ...:PROTOCOL:DUT_TYPE renamed from ...:PROTOCOL:DUT_TYPE?	CONF:NST:RX:DUT_TYPE READ:NST:RX:DUT_TYPE?	added added	CONF:NST:MFG:DUT_TYPE READ:NST:MFG:DUT_TYPE?	added added	CONF:NST:TX:TX_POLARITY READ:NST:TX:TX_POLARITY?	added added	CONF:NST:RX:RX_POLARITY READ:NST:RX:RX_POLARITY?	added added	CONF:NST:MFG:TX_POLARITY READ:NST:MFG:TX_POLARITY?	added added	CONF:NST:MFG:RX_POLARITY READ:NST:MFG:RX_POLARITY?	added added
CONF:PROTOCOL:NET_ID_MSB READ:PROTOCOL:NET_ID_MSB?	added added																																																													
CONF:PROTOCOL:NWK_ADDR READ:PROTOCOL:NWK_ADDR?	added added																																																													
CONF:PROTOCOL:BEACON_TIME_OFFSET READ:PROTOCOL:BEACON_TIME_OFFSET?	added added																																																													
Commands for LINK Parameters																																																														
Commands for SENSITIVITY parameters																																																														
CONF:SENSITIVITY:TARGET_CH_MASK READ:SENSITIVITY:TARGET_CH_MASK?	added added																																																													
CONF:SENSITIVITY:TARGET_DR READ:SENSITIVITY:TARGET_DR?	renamed from ...:SF renamed from ...:SF?																																																													
Commands for RF Parameters																																																														
Commands for NST Parameters																																																														
CONF:NST:TX:FM_DEVIATION READ:NST:TX:FM_DEVIATION?	added added																																																													
CONF:NST:MFG:FM_DEVIATION READ:NST:MFG:FM_DEVIATION?	added added																																																													
CONF:NST:TX:DATA_RATE READ:NST:TX:DATA_RATE?	added added																																																													
CONF:NST:RX:DATA_RATE READ:NST:RX:DATA_RATE?	added added																																																													
CONF:NST:MFG:DATA_RATE READ:NST:MFG:DATA_RATE?	added added																																																													
CONF:NST:TX:SYNC_WORD_SIZE READ:NST:TX:SYNC_WORD_SIZE?	added added																																																													
CONF:NST:RX:SYNC_WORD_SIZE READ:NST:RX:SYNC_WORD_SIZE?	added added																																																													
CONF:NST:MFG:SYNC_WORD_SIZE READ:NST:MFG:SYNC_WORD_SIZE?	added added																																																													
CONF:NST:TX:SYNC_WORD READ:NST:TX:SYNC_WORD?	added added																																																													
CONF:NST:RX:SYNC_WORD READ:NST:RX:SYNC_WORD?	added added																																																													
CONF:NST:MFG:SYNC_WORD READ:NST:MFG:SYNC_WORD?	added added																																																													
CONF:NST:TX:MODULATION READ:NST:TX:MODULATION?	renamed from ...:MODE renamed from ...:MODE?																																																													
CONF:NST:RX:MODULATION READ:NST:RX:MODULATION?	added added																																																													
CONF:NST:MFG:MODULATION READ:NST:MFG:MODULATION?	added added																																																													
CONF:NST:TX:DUT_TYPE READ:NST:TX:DUT_TYPE?	renamed from ...:PROTOCOL:DUT_TYPE renamed from ...:PROTOCOL:DUT_TYPE?																																																													
CONF:NST:RX:DUT_TYPE READ:NST:RX:DUT_TYPE?	added added																																																													
CONF:NST:MFG:DUT_TYPE READ:NST:MFG:DUT_TYPE?	added added																																																													
CONF:NST:TX:TX_POLARITY READ:NST:TX:TX_POLARITY?	added added																																																													
CONF:NST:RX:RX_POLARITY READ:NST:RX:RX_POLARITY?	added added																																																													
CONF:NST:MFG:TX_POLARITY READ:NST:MFG:TX_POLARITY?	added added																																																													
CONF:NST:MFG:RX_POLARITY READ:NST:MFG:RX_POLARITY?	added added																																																													
V1.13	2018.07.19	<ul style="list-style-type: none"> - Firmware version: V1.13 - Updated all pictures according to FW V1.13 - Added a function of Periodic Downlink in Class C mode of EDT - Added or renamed remote commands. See 4.4 for details. <table border="1"> <tr> <td colspan="2">Commands for PROTOCOL Parameters</td> </tr> <tr> <td>CONF:PROTOCOL:SET TEST MODE</td> <td>added</td> </tr> </table>	Commands for PROTOCOL Parameters		CONF:PROTOCOL:SET TEST MODE	added																																																								
Commands for PROTOCOL Parameters																																																														
CONF:PROTOCOL:SET TEST MODE	added																																																													

		<table border="1"> <tr><td>READ:PROTOCOL:SET TEST MODE?</td><td>added</td></tr> <tr><td>CONF:PROTOCOL:SET_CH_MASK</td><td>added</td></tr> <tr><td>READ:PROTOCOL:SET_CH_MASK?</td><td>added</td></tr> <tr><td>CONF:PROTOCOL:CLAA_MODE</td><td>added</td></tr> <tr><td>READ:PROTOCOL:CLAA_MODE?</td><td>added</td></tr> <tr><td>CONF:PROTOCOL:PERIODIC_DOWNLINK</td><td>added</td></tr> <tr><td>READ:PROTOCOL:PERIODIC_DOWNLINK?</td><td>added</td></tr> <tr><td colspan="2">Commands for LINK Parameters</td></tr> <tr><td>CONF:LINK:SET_TM_AT_OTAA</td><td>deleted</td></tr> <tr><td>READ:LINK:SET_TM_AT_OTAA?</td><td>deleted</td></tr> <tr><td>CONF:LINK:SET_CH_AT_OTAA</td><td>deleted</td></tr> <tr><td>READ:LINK:SET_CH_AT_OTAA?</td><td>deleted</td></tr> <tr><td>CONF:LINK:ADR_MORE_CH_MASK</td><td>added</td></tr> <tr><td>READ:LINK:ADR_MORE_CH_MASK?</td><td>added</td></tr> <tr><td>CONF:LINK:ADR_CH_MASK2</td><td>added</td></tr> <tr><td>READ:LINK:ADR_CH_MASK2?</td><td>added</td></tr> <tr><td>CONF:LINK:ADR_CH_MASK3</td><td>added</td></tr> <tr><td>READ:LINK:ADR_CH_MASK3?</td><td>added</td></tr> <tr><td>CONF:LINK:ADR_MASK2_CTRL</td><td>added</td></tr> <tr><td>READ:LINK:ADR_MASK2_CTRL?</td><td>added</td></tr> <tr><td>CONF:LINK:ADR_MASK3_CTRL</td><td>added</td></tr> <tr><td>READ:LINK:ADR_MASK3_CTRL?</td><td>added</td></tr> <tr><td>CONF:LINK:DWELL_DISPLAY</td><td>added</td></tr> <tr><td>READ:LINK:DWELL_DISPLAY?</td><td>added</td></tr> <tr><td colspan="2">Commands for SENSITIVITY parameters</td></tr> <tr><td>CONF:SENSITIVITY:RX2_FREQ</td><td>added</td></tr> <tr><td>READ:SENSITIVITY:RX2_FREQ?</td><td>added</td></tr> <tr><td colspan="2">Commands for RF Parameters</td></tr> <tr><td>CONF:RF:CH_GROUP</td><td>renamed from ...CH_GROUP_A</td></tr> <tr><td>READ:RF:CH_GROUP?</td><td>renamed from ...CH_GROUP_A?</td></tr> <tr><td>CONF:RF:CH_GROUP_B</td><td>deleted</td></tr> <tr><td>READ:RF:CH_GROUP_B?</td><td>deleted</td></tr> <tr><td>CONF:RF:CH_MODE</td><td>added</td></tr> <tr><td>READ:RF:CH_MODE?</td><td>added</td></tr> </table>	READ:PROTOCOL:SET TEST MODE?	added	CONF:PROTOCOL:SET_CH_MASK	added	READ:PROTOCOL:SET_CH_MASK?	added	CONF:PROTOCOL:CLAA_MODE	added	READ:PROTOCOL:CLAA_MODE?	added	CONF:PROTOCOL:PERIODIC_DOWNLINK	added	READ:PROTOCOL:PERIODIC_DOWNLINK?	added	Commands for LINK Parameters		CONF:LINK:SET_TM_AT_OTAA	deleted	READ:LINK:SET_TM_AT_OTAA?	deleted	CONF:LINK:SET_CH_AT_OTAA	deleted	READ:LINK:SET_CH_AT_OTAA?	deleted	CONF:LINK:ADR_MORE_CH_MASK	added	READ:LINK:ADR_MORE_CH_MASK?	added	CONF:LINK:ADR_CH_MASK2	added	READ:LINK:ADR_CH_MASK2?	added	CONF:LINK:ADR_CH_MASK3	added	READ:LINK:ADR_CH_MASK3?	added	CONF:LINK:ADR_MASK2_CTRL	added	READ:LINK:ADR_MASK2_CTRL?	added	CONF:LINK:ADR_MASK3_CTRL	added	READ:LINK:ADR_MASK3_CTRL?	added	CONF:LINK:DWELL_DISPLAY	added	READ:LINK:DWELL_DISPLAY?	added	Commands for SENSITIVITY parameters		CONF:SENSITIVITY:RX2_FREQ	added	READ:SENSITIVITY:RX2_FREQ?	added	Commands for RF Parameters		CONF:RF:CH_GROUP	renamed from ...CH_GROUP_A	READ:RF:CH_GROUP?	renamed from ...CH_GROUP_A?	CONF:RF:CH_GROUP_B	deleted	READ:RF:CH_GROUP_B?	deleted	CONF:RF:CH_MODE	added	READ:RF:CH_MODE?	added
READ:PROTOCOL:SET TEST MODE?	added																																																																					
CONF:PROTOCOL:SET_CH_MASK	added																																																																					
READ:PROTOCOL:SET_CH_MASK?	added																																																																					
CONF:PROTOCOL:CLAA_MODE	added																																																																					
READ:PROTOCOL:CLAA_MODE?	added																																																																					
CONF:PROTOCOL:PERIODIC_DOWNLINK	added																																																																					
READ:PROTOCOL:PERIODIC_DOWNLINK?	added																																																																					
Commands for LINK Parameters																																																																						
CONF:LINK:SET_TM_AT_OTAA	deleted																																																																					
READ:LINK:SET_TM_AT_OTAA?	deleted																																																																					
CONF:LINK:SET_CH_AT_OTAA	deleted																																																																					
READ:LINK:SET_CH_AT_OTAA?	deleted																																																																					
CONF:LINK:ADR_MORE_CH_MASK	added																																																																					
READ:LINK:ADR_MORE_CH_MASK?	added																																																																					
CONF:LINK:ADR_CH_MASK2	added																																																																					
READ:LINK:ADR_CH_MASK2?	added																																																																					
CONF:LINK:ADR_CH_MASK3	added																																																																					
READ:LINK:ADR_CH_MASK3?	added																																																																					
CONF:LINK:ADR_MASK2_CTRL	added																																																																					
READ:LINK:ADR_MASK2_CTRL?	added																																																																					
CONF:LINK:ADR_MASK3_CTRL	added																																																																					
READ:LINK:ADR_MASK3_CTRL?	added																																																																					
CONF:LINK:DWELL_DISPLAY	added																																																																					
READ:LINK:DWELL_DISPLAY?	added																																																																					
Commands for SENSITIVITY parameters																																																																						
CONF:SENSITIVITY:RX2_FREQ	added																																																																					
READ:SENSITIVITY:RX2_FREQ?	added																																																																					
Commands for RF Parameters																																																																						
CONF:RF:CH_GROUP	renamed from ...CH_GROUP_A																																																																					
READ:RF:CH_GROUP?	renamed from ...CH_GROUP_A?																																																																					
CONF:RF:CH_GROUP_B	deleted																																																																					
READ:RF:CH_GROUP_B?	deleted																																																																					
CONF:RF:CH_MODE	added																																																																					
READ:RF:CH_MODE?	added																																																																					
V1.12	2018.04.20	<ul style="list-style-type: none"> - Firmware version: V1.12 - Updated all pictures according to FW V1.12 - Added explanation about new MAC commands of test mode; CONFIRMED_TM, UNCONFIRMED_TM, ECHO_REQUEST_TM, TRIGGER_JOIN_REQ_TM, ENABLE_CW_MODE_TM. See 3.3.3 for details. - Added the MFG function in NST mode for automated manufacturing tests. See 3.19 for details. - Added or renamed remote commands. See 4.4 for details. <table border="1"> <tr><td colspan="2">Commands for PROTOCOL Parameters</td></tr> <tr><td>CONF:PROTOCOL:DUT_TYPE</td><td>renamed from ...MESSAGE_TYPE</td></tr> <tr><td>READ:PROTOCOL:DUT_TYPE?</td><td>renamed from ...MESSAGE_TYPE?</td></tr> <tr><td colspan="2">Commands for LINK Parameters</td></tr> <tr><td>CONF:LINK:INSTANT_MAC_CMD</td><td>parameters added; CONFIRMED_TM, UNCONFIRMED_TM, ECHO_REQUEST_TM, TRIGGER_JOIN_REQ_TM, ENABLE_CE_MODE_TM</td></tr> <tr><td>CONF:LINK:TIME_DISPLAY</td><td>added</td></tr> <tr><td>READ:LINK:TIME_DISPLAY?</td><td>added</td></tr> <tr><td>CONF:LINK:FCNT_DISPLAY</td><td>added</td></tr> <tr><td>READ:LINK:FCNT_DISPLAY?</td><td>added</td></tr> <tr><td>CONF:LINK:ADR_DISPLAY</td><td>added</td></tr> <tr><td>READ:LINK:ADR_DISPLAY?</td><td>added</td></tr> <tr><td>CONF:LINK:ACK_DISPLAY</td><td>added</td></tr> <tr><td>READ:LINK:ACK_DISPLAY?</td><td>added</td></tr> <tr><td>CONF:LINK:CLASS_B_DISPLAY</td><td>added</td></tr> <tr><td>READ:LINK:CLASS_B_DISPLAY?</td><td>added</td></tr> <tr><td>CONF:LINK:PORT_DISPLAY</td><td>added</td></tr> <tr><td>READ:LINK:PORT_DISPLAY?</td><td>added</td></tr> <tr><td>CONF:LINK:MSG_TYPE_DISPLAY</td><td>added</td></tr> </table>	Commands for PROTOCOL Parameters		CONF:PROTOCOL:DUT_TYPE	renamed from ...MESSAGE_TYPE	READ:PROTOCOL:DUT_TYPE?	renamed from ...MESSAGE_TYPE?	Commands for LINK Parameters		CONF:LINK:INSTANT_MAC_CMD	parameters added; CONFIRMED_TM, UNCONFIRMED_TM, ECHO_REQUEST_TM, TRIGGER_JOIN_REQ_TM, ENABLE_CE_MODE_TM	CONF:LINK:TIME_DISPLAY	added	READ:LINK:TIME_DISPLAY?	added	CONF:LINK:FCNT_DISPLAY	added	READ:LINK:FCNT_DISPLAY?	added	CONF:LINK:ADR_DISPLAY	added	READ:LINK:ADR_DISPLAY?	added	CONF:LINK:ACK_DISPLAY	added	READ:LINK:ACK_DISPLAY?	added	CONF:LINK:CLASS_B_DISPLAY	added	READ:LINK:CLASS_B_DISPLAY?	added	CONF:LINK:PORT_DISPLAY	added	READ:LINK:PORT_DISPLAY?	added	CONF:LINK:MSG_TYPE_DISPLAY	added																																
Commands for PROTOCOL Parameters																																																																						
CONF:PROTOCOL:DUT_TYPE	renamed from ...MESSAGE_TYPE																																																																					
READ:PROTOCOL:DUT_TYPE?	renamed from ...MESSAGE_TYPE?																																																																					
Commands for LINK Parameters																																																																						
CONF:LINK:INSTANT_MAC_CMD	parameters added; CONFIRMED_TM, UNCONFIRMED_TM, ECHO_REQUEST_TM, TRIGGER_JOIN_REQ_TM, ENABLE_CE_MODE_TM																																																																					
CONF:LINK:TIME_DISPLAY	added																																																																					
READ:LINK:TIME_DISPLAY?	added																																																																					
CONF:LINK:FCNT_DISPLAY	added																																																																					
READ:LINK:FCNT_DISPLAY?	added																																																																					
CONF:LINK:ADR_DISPLAY	added																																																																					
READ:LINK:ADR_DISPLAY?	added																																																																					
CONF:LINK:ACK_DISPLAY	added																																																																					
READ:LINK:ACK_DISPLAY?	added																																																																					
CONF:LINK:CLASS_B_DISPLAY	added																																																																					
READ:LINK:CLASS_B_DISPLAY?	added																																																																					
CONF:LINK:PORT_DISPLAY	added																																																																					
READ:LINK:PORT_DISPLAY?	added																																																																					
CONF:LINK:MSG_TYPE_DISPLAY	added																																																																					

		<table border="1"> <tr><td>READ:LINK:MSG_TYPE_DISPLAY?</td><td>added</td></tr> <tr><td>CONF:LINK:POW_DISPLAY</td><td>added</td></tr> <tr><td>READ:LINK:POW_DISPLAY?</td><td>added</td></tr> <tr><td>CONF:LINK:DR_DISPLAY</td><td>added</td></tr> <tr><td>READ:LINK:DR_DISPLAY?</td><td>added</td></tr> <tr><td>CONF:LINK:DELAY_DISPLAY</td><td>added</td></tr> <tr><td>READ:LINK:DELAY_DISPLAY?</td><td>added</td></tr> <tr><td>CONF:LINK:ADRACKREQ_DISPLAY</td><td>added</td></tr> <tr><td>READ:LINK:ADRACKREQ_DISPLAY?</td><td>added</td></tr> <tr><td>CONF:LINK:FPENDING_DISPLAY</td><td>added</td></tr> <tr><td>READ:LINK:FPENDING_DISPLAY?</td><td>added</td></tr> <tr><td>CONF:LINK:ECHO_LEN</td><td>added</td></tr> <tr><td>READ:LINK:ECHO_LEN?</td><td>added</td></tr> <tr><td>CONF:LINK:CW_TIMEOUT</td><td>added</td></tr> <tr><td>READ:LINK:CW_TIMEOUT?</td><td>added</td></tr> <tr><td>CONF:LINK:CW_FREQ</td><td>added</td></tr> <tr><td>READ:LINK:CW_FREQ?</td><td>added</td></tr> <tr><td>CONF:LINK:CW_POW</td><td>added</td></tr> <tr><td>READ:LINK:CW_POW?</td><td>added</td></tr> <tr><td colspan="2">Commands for NST Parameters</td></tr> <tr><td>CONF:NST:MFG:PER_CRITERIA</td><td>added</td></tr> <tr><td>READ:NST:MFG:PER_CRITERIA?</td><td>added</td></tr> <tr><td>CONF:NST:MFG:POW_CRITERIA_UPPER</td><td>added</td></tr> <tr><td>READ:NST:MFG:POW_CRITERIA_UPPER?</td><td>added</td></tr> <tr><td>CONF:NST:MFG:POW_CRITERIA_LOWER</td><td>added</td></tr> <tr><td>READ:NST:MFG:POW_CRITERIA_LOWER?</td><td>added</td></tr> <tr><td>READ:NST:MFG:PER?</td><td>added</td></tr> <tr><td>READ:NST:MFG:POW?</td><td>added</td></tr> <tr><td>READ:NST:MFG:STATUS?</td><td>added</td></tr> <tr><td>CONF:NST:MFG:TIME_OUT</td><td>added</td></tr> <tr><td>READ:NST:MFG:TIME_OUT?</td><td>added</td></tr> <tr><td>CONF:NST:MFG:MODE</td><td>added</td></tr> <tr><td>READ:NST:MFG:MODE?</td><td>added</td></tr> <tr><td>CONF:NST:MFG:INTERVAL</td><td>added</td></tr> <tr><td>READ:NST:MFG:INTERVAL?</td><td>added</td></tr> <tr><td>CONF:NST:MFG:BW</td><td>added</td></tr> <tr><td>READ:NST:MFG:BW?</td><td>added</td></tr> <tr><td>CONF:NST:MFG:SF</td><td>added</td></tr> <tr><td>READ:NST:MFG:SF?</td><td>added</td></tr> <tr><td>CONF:NST:MFG:CR</td><td>added</td></tr> <tr><td>READ:NST:MFG:CR?</td><td>added</td></tr> <tr><td>CONF:NST:MFG:PAYLOAD_SIZE</td><td>added</td></tr> <tr><td>READ:NST:MFG:PAYLOAD_SIZE?</td><td>added</td></tr> <tr><td>CONF:NST:MFG:PREAMBLE_SIZE</td><td>added</td></tr> <tr><td>READ:NST:MFG:PREAMBLE_SIZE?</td><td>added</td></tr> <tr><td>EXEC:NST:MFG:RUN</td><td>added</td></tr> <tr><td>EXEC:NST:MFG:STOP</td><td>added</td></tr> <tr><td>CONF:NST:MFG:REPEAT_NUM</td><td>added</td></tr> <tr><td>READ:NST:MFG:REPEAT_NUM?</td><td>added</td></tr> <tr><td>CONF:NST:MFG:NETWORK</td><td>added</td></tr> <tr><td>READ:NST:MFG:NETWORK?</td><td>added</td></tr> <tr><td>READ:NST:MFG:DUT_INFO?</td><td>added</td></tr> </table>	READ:LINK:MSG_TYPE_DISPLAY?	added	CONF:LINK:POW_DISPLAY	added	READ:LINK:POW_DISPLAY?	added	CONF:LINK:DR_DISPLAY	added	READ:LINK:DR_DISPLAY?	added	CONF:LINK:DELAY_DISPLAY	added	READ:LINK:DELAY_DISPLAY?	added	CONF:LINK:ADRACKREQ_DISPLAY	added	READ:LINK:ADRACKREQ_DISPLAY?	added	CONF:LINK:FPENDING_DISPLAY	added	READ:LINK:FPENDING_DISPLAY?	added	CONF:LINK:ECHO_LEN	added	READ:LINK:ECHO_LEN?	added	CONF:LINK:CW_TIMEOUT	added	READ:LINK:CW_TIMEOUT?	added	CONF:LINK:CW_FREQ	added	READ:LINK:CW_FREQ?	added	CONF:LINK:CW_POW	added	READ:LINK:CW_POW?	added	Commands for NST Parameters		CONF:NST:MFG:PER_CRITERIA	added	READ:NST:MFG:PER_CRITERIA?	added	CONF:NST:MFG:POW_CRITERIA_UPPER	added	READ:NST:MFG:POW_CRITERIA_UPPER?	added	CONF:NST:MFG:POW_CRITERIA_LOWER	added	READ:NST:MFG:POW_CRITERIA_LOWER?	added	READ:NST:MFG:PER?	added	READ:NST:MFG:POW?	added	READ:NST:MFG:STATUS?	added	CONF:NST:MFG:TIME_OUT	added	READ:NST:MFG:TIME_OUT?	added	CONF:NST:MFG:MODE	added	READ:NST:MFG:MODE?	added	CONF:NST:MFG:INTERVAL	added	READ:NST:MFG:INTERVAL?	added	CONF:NST:MFG:BW	added	READ:NST:MFG:BW?	added	CONF:NST:MFG:SF	added	READ:NST:MFG:SF?	added	CONF:NST:MFG:CR	added	READ:NST:MFG:CR?	added	CONF:NST:MFG:PAYLOAD_SIZE	added	READ:NST:MFG:PAYLOAD_SIZE?	added	CONF:NST:MFG:PREAMBLE_SIZE	added	READ:NST:MFG:PREAMBLE_SIZE?	added	EXEC:NST:MFG:RUN	added	EXEC:NST:MFG:STOP	added	CONF:NST:MFG:REPEAT_NUM	added	READ:NST:MFG:REPEAT_NUM?	added	CONF:NST:MFG:NETWORK	added	READ:NST:MFG:NETWORK?	added	READ:NST:MFG:DUT_INFO?	added
READ:LINK:MSG_TYPE_DISPLAY?	added																																																																																																									
CONF:LINK:POW_DISPLAY	added																																																																																																									
READ:LINK:POW_DISPLAY?	added																																																																																																									
CONF:LINK:DR_DISPLAY	added																																																																																																									
READ:LINK:DR_DISPLAY?	added																																																																																																									
CONF:LINK:DELAY_DISPLAY	added																																																																																																									
READ:LINK:DELAY_DISPLAY?	added																																																																																																									
CONF:LINK:ADRACKREQ_DISPLAY	added																																																																																																									
READ:LINK:ADRACKREQ_DISPLAY?	added																																																																																																									
CONF:LINK:FPENDING_DISPLAY	added																																																																																																									
READ:LINK:FPENDING_DISPLAY?	added																																																																																																									
CONF:LINK:ECHO_LEN	added																																																																																																									
READ:LINK:ECHO_LEN?	added																																																																																																									
CONF:LINK:CW_TIMEOUT	added																																																																																																									
READ:LINK:CW_TIMEOUT?	added																																																																																																									
CONF:LINK:CW_FREQ	added																																																																																																									
READ:LINK:CW_FREQ?	added																																																																																																									
CONF:LINK:CW_POW	added																																																																																																									
READ:LINK:CW_POW?	added																																																																																																									
Commands for NST Parameters																																																																																																										
CONF:NST:MFG:PER_CRITERIA	added																																																																																																									
READ:NST:MFG:PER_CRITERIA?	added																																																																																																									
CONF:NST:MFG:POW_CRITERIA_UPPER	added																																																																																																									
READ:NST:MFG:POW_CRITERIA_UPPER?	added																																																																																																									
CONF:NST:MFG:POW_CRITERIA_LOWER	added																																																																																																									
READ:NST:MFG:POW_CRITERIA_LOWER?	added																																																																																																									
READ:NST:MFG:PER?	added																																																																																																									
READ:NST:MFG:POW?	added																																																																																																									
READ:NST:MFG:STATUS?	added																																																																																																									
CONF:NST:MFG:TIME_OUT	added																																																																																																									
READ:NST:MFG:TIME_OUT?	added																																																																																																									
CONF:NST:MFG:MODE	added																																																																																																									
READ:NST:MFG:MODE?	added																																																																																																									
CONF:NST:MFG:INTERVAL	added																																																																																																									
READ:NST:MFG:INTERVAL?	added																																																																																																									
CONF:NST:MFG:BW	added																																																																																																									
READ:NST:MFG:BW?	added																																																																																																									
CONF:NST:MFG:SF	added																																																																																																									
READ:NST:MFG:SF?	added																																																																																																									
CONF:NST:MFG:CR	added																																																																																																									
READ:NST:MFG:CR?	added																																																																																																									
CONF:NST:MFG:PAYLOAD_SIZE	added																																																																																																									
READ:NST:MFG:PAYLOAD_SIZE?	added																																																																																																									
CONF:NST:MFG:PREAMBLE_SIZE	added																																																																																																									
READ:NST:MFG:PREAMBLE_SIZE?	added																																																																																																									
EXEC:NST:MFG:RUN	added																																																																																																									
EXEC:NST:MFG:STOP	added																																																																																																									
CONF:NST:MFG:REPEAT_NUM	added																																																																																																									
READ:NST:MFG:REPEAT_NUM?	added																																																																																																									
CONF:NST:MFG:NETWORK	added																																																																																																									
READ:NST:MFG:NETWORK?	added																																																																																																									
READ:NST:MFG:DUT_INFO?	added																																																																																																									
V1.11	2018.03.19	<ul style="list-style-type: none"> - Firmware version: V1.11 - Updated all pictures according to FW V1.11 - Revised the usage of Signal Generator and Signal Analyzer in NST mode - Added protocol parameters to expand a function of test frame generation/analysis in NST mode - Added explanation about additional MAC commands for LoRaWAN V1.1 - Added or renamed remote commands. See 4.4 for details. <table border="1"> <tr><td colspan="2">Commands for RF Parameters</td></tr> <tr><td>CONF:RF:UL_CH</td><td>Added For EDT, n=3 (EU868, IN865) or n=4 (KR922, AS923, EU433) For GWT, all channel frequencies are editable.</td></tr> </table>	Commands for RF Parameters		CONF:RF:UL_CH	Added For EDT, n=3 (EU868, IN865) or n=4 (KR922, AS923, EU433) For GWT, all channel frequencies are editable.																																																																																																				
Commands for RF Parameters																																																																																																										
CONF:RF:UL_CH	Added For EDT, n=3 (EU868, IN865) or n=4 (KR922, AS923, EU433) For GWT, all channel frequencies are editable.																																																																																																									

		<table border="1"> <thead> <tr> <th colspan="2">Commands for PROTOCOL Parameters</th> </tr> </thead> <tbody> <tr> <td>CONF:PROTOCOL:MESSAGE_TYEP</td> <td>Added</td> </tr> <tr> <td>READ:PROTOCOL:MESSAGE_TYEP?</td> <td>Added</td> </tr> <tr> <td>CONF:PROTOCOL:MAC_FORMAT</td> <td>Added</td> </tr> <tr> <td>READ:PROTOCOL:MAC_FORMAT?</td> <td>Added</td> </tr> <tr> <td>CONF:PROTOCOL:FCNT</td> <td>Added</td> </tr> <tr> <td>READ:PROTOCOL:FCNT?</td> <td>Added</td> </tr> <tr> <td>CONF:PROTOCOL:FCNT_MODE</td> <td>Added</td> </tr> <tr> <td>READ:PROTOCOL:FCNT_MODE?</td> <td>Added</td> </tr> <tr> <td>CONF:PROTOCOL:ADR_ACK_REQ</td> <td>Added</td> </tr> <tr> <td>READ:PROTOCOL:ADR_ACK_REQ?</td> <td>Added</td> </tr> <tr> <td>CONF:PROTOCOL:ACK</td> <td>Added</td> </tr> <tr> <td>READ:PROTOCOL:ACK?</td> <td>Added</td> </tr> <tr> <td>CONF:PROTOCOL:FPENDING</td> <td>Added</td> </tr> <tr> <td>READ:PROTOCOL:FPENDING?</td> <td>Added</td> </tr> </tbody> </table>	Commands for PROTOCOL Parameters		CONF:PROTOCOL:MESSAGE_TYEP	Added	READ:PROTOCOL:MESSAGE_TYEP?	Added	CONF:PROTOCOL:MAC_FORMAT	Added	READ:PROTOCOL:MAC_FORMAT?	Added	CONF:PROTOCOL:FCNT	Added	READ:PROTOCOL:FCNT?	Added	CONF:PROTOCOL:FCNT_MODE	Added	READ:PROTOCOL:FCNT_MODE?	Added	CONF:PROTOCOL:ADR_ACK_REQ	Added	READ:PROTOCOL:ADR_ACK_REQ?	Added	CONF:PROTOCOL:ACK	Added	READ:PROTOCOL:ACK?	Added	CONF:PROTOCOL:FPENDING	Added	READ:PROTOCOL:FPENDING?	Added																																																						
Commands for PROTOCOL Parameters																																																																																						
CONF:PROTOCOL:MESSAGE_TYEP	Added																																																																																					
READ:PROTOCOL:MESSAGE_TYEP?	Added																																																																																					
CONF:PROTOCOL:MAC_FORMAT	Added																																																																																					
READ:PROTOCOL:MAC_FORMAT?	Added																																																																																					
CONF:PROTOCOL:FCNT	Added																																																																																					
READ:PROTOCOL:FCNT?	Added																																																																																					
CONF:PROTOCOL:FCNT_MODE	Added																																																																																					
READ:PROTOCOL:FCNT_MODE?	Added																																																																																					
CONF:PROTOCOL:ADR_ACK_REQ	Added																																																																																					
READ:PROTOCOL:ADR_ACK_REQ?	Added																																																																																					
CONF:PROTOCOL:ACK	Added																																																																																					
READ:PROTOCOL:ACK?	Added																																																																																					
CONF:PROTOCOL:FPENDING	Added																																																																																					
READ:PROTOCOL:FPENDING?	Added																																																																																					
V1.10	2017.12.27	<ul style="list-style-type: none"> - Firmware version: V1.10 - Added a section of Usage of Link Analyzer for Class B EDT - Added a section of Usage of Link Analyzer for Class B GWT - Updated activation procedures for LoRaWAN V1.1 - Class B support (V1.0.2 classB draft4 and V1.1) - LoRaWAN V1.1 support - Added or renamed remote commands. See 4.4 for details. <table border="1"> <thead> <tr> <th colspan="2">Commands for RF Parameters</th> </tr> </thead> <tbody> <tr> <td>READ:RF:UL_CH?</td> <td>added (n=0,1,...,7)</td> </tr> <tr> <td>READ:RF:DL_CH?</td> <td>added (n=0,1,...,7)</td> </tr> <tr> <th colspan="2">Commands for Protocol Parameter</th> </tr> <tr> <td>CONF:PROTOCOL:DOWNLINK_SLOT</td> <td>renamed from ...RX_WINDOW</td> </tr> <tr> <td>READ:PROTOCOL:DOWNLINK_SLOT?</td> <td>renamed from ...RX_WINDOW?</td> </tr> <tr> <td>CONF:PROTOCOL:NETWORK</td> <td>renamed from ...SYNC_WORD</td> </tr> <tr> <td>READ:PROTOCOL:NETWORK?</td> <td>renamed from ...SYNC_WORD?</td> </tr> <tr> <td>CONF:PROTOCOL:UPLINK_DR</td> <td>renamed from ...UL_DR</td> </tr> <tr> <td>READ:PROTOCOL:UPLINK_DR?</td> <td>renamed from ...UL_DR?</td> </tr> <tr> <td>CONF:PROTOCOL:UPDATE_FCNT</td> <td>added</td> </tr> <tr> <td>READ:PROTOCOL:UPDATE_FCNT?</td> <td>added</td> </tr> <tr> <td>CONF:PROTOCOL:PING_PERIODICITY</td> <td>added</td> </tr> <tr> <td>READ:PROTOCOL:PING_PERIODICITY?</td> <td>added</td> </tr> <tr> <td>CONF:PROTOCOL:PROTOCOL_VER</td> <td>added</td> </tr> <tr> <td>READ:PROTOCOL:PROTOCOL_VER?</td> <td>added</td> </tr> <tr> <td>CONF:PROTOCOL:NWK_KEY</td> <td>added (for LoRaWAN V1.1)</td> </tr> <tr> <td>READ:PROTOCOL:NWK_KEY?</td> <td>added (for LoRaWAN V1.1)</td> </tr> <tr> <td>CONF:PROTOCOL:FNWKS_IKEY</td> <td>added (for LoRaWAN V1.1)</td> </tr> <tr> <td>READ:PROTOCOL:FNWKS_IKEY?</td> <td>added (for LoRaWAN V1.1)</td> </tr> <tr> <td>CONF:PROTOCOL:SNWKS_IKEY</td> <td>added (for LoRaWAN V1.1)</td> </tr> <tr> <td>READ:PROTOCOL:SNWKS_IKEY?</td> <td>added (for LoRaWAN V1.1)</td> </tr> <tr> <td>CONF:PROTOCOL:NWKS_EKEY</td> <td>added (for LoRaWAN V1.1)</td> </tr> <tr> <td>READ:PROTOCOL:NWKS_EKEY?</td> <td>added (for LoRaWAN V1.1)</td> </tr> <tr> <td>READ:PROTOCOL:DL_DWELL_TIME?</td> <td>added</td> </tr> <tr> <td>READ:PROTOCOL:UL_DWELL_TIME?</td> <td>added</td> </tr> <tr> <td>CONF:PROTOCOL:LATITUDE</td> <td>added</td> </tr> <tr> <td>READ:PROTOCOL:LATITUDE?</td> <td>added</td> </tr> <tr> <td>CONF:PROTOCOL:LONGITUDE</td> <td>added</td> </tr> <tr> <td>READ:PROTOCOL:LONGITUDE?</td> <td>added</td> </tr> <tr> <td>CONF:PROTOCOL:UPDATE_NFCNT</td> <td>added (for LoRaWAN V1.1)</td> </tr> <tr> <td>READ:PROTOCOL:UPDATE_NFCNT?</td> <td>added (for LoRaWAN V1.1)</td> </tr> <tr> <td>CONF:PROTOCOL:UPDATE_AFCNT</td> <td>added (for LoRaWAN V1.1)</td> </tr> <tr> <td>READ:PROTOCOL:UPDATE_AFCNT?</td> <td>added (for LoRaWAN V1.1)</td> </tr> <tr> <td>CONF:PROTOCOL:JOIN_EUI</td> <td>added (for LoRaWAN V1.1)</td> </tr> <tr> <td>READ:PROTOCOL:JOIN_EUI?</td> <td>added (for LoRaWAN V1.1)</td> </tr> <tr> <th colspan="2">Commands for LINK</th> </tr> <tr> <td>CONF:LINK:MIC_ERR_DISPLAY</td> <td>added</td> </tr> <tr> <td>READ:LINK:MIC_ERR_DISPLAY?</td> <td>added</td> </tr> <tr> <td>CONF:LINK:SET_TM_AT_OTAA</td> <td>added</td> </tr> <tr> <td>READ:LINK:SET_TM_AT_OTAA?</td> <td>added</td> </tr> <tr> <td>CONF:LINK:SET_CH_AT_OTAA</td> <td>added</td> </tr> </tbody> </table>	Commands for RF Parameters		READ:RF:UL_CH?	added (n=0,1,...,7)	READ:RF:DL_CH?	added (n=0,1,...,7)	Commands for Protocol Parameter		CONF:PROTOCOL:DOWNLINK_SLOT	renamed from ...RX_WINDOW	READ:PROTOCOL:DOWNLINK_SLOT?	renamed from ...RX_WINDOW?	CONF:PROTOCOL:NETWORK	renamed from ...SYNC_WORD	READ:PROTOCOL:NETWORK?	renamed from ...SYNC_WORD?	CONF:PROTOCOL:UPLINK_DR	renamed from ...UL_DR	READ:PROTOCOL:UPLINK_DR?	renamed from ...UL_DR?	CONF:PROTOCOL:UPDATE_FCNT	added	READ:PROTOCOL:UPDATE_FCNT?	added	CONF:PROTOCOL:PING_PERIODICITY	added	READ:PROTOCOL:PING_PERIODICITY?	added	CONF:PROTOCOL:PROTOCOL_VER	added	READ:PROTOCOL:PROTOCOL_VER?	added	CONF:PROTOCOL:NWK_KEY	added (for LoRaWAN V1.1)	READ:PROTOCOL:NWK_KEY?	added (for LoRaWAN V1.1)	CONF:PROTOCOL:FNWKS_IKEY	added (for LoRaWAN V1.1)	READ:PROTOCOL:FNWKS_IKEY?	added (for LoRaWAN V1.1)	CONF:PROTOCOL:SNWKS_IKEY	added (for LoRaWAN V1.1)	READ:PROTOCOL:SNWKS_IKEY?	added (for LoRaWAN V1.1)	CONF:PROTOCOL:NWKS_EKEY	added (for LoRaWAN V1.1)	READ:PROTOCOL:NWKS_EKEY?	added (for LoRaWAN V1.1)	READ:PROTOCOL:DL_DWELL_TIME?	added	READ:PROTOCOL:UL_DWELL_TIME?	added	CONF:PROTOCOL:LATITUDE	added	READ:PROTOCOL:LATITUDE?	added	CONF:PROTOCOL:LONGITUDE	added	READ:PROTOCOL:LONGITUDE?	added	CONF:PROTOCOL:UPDATE_NFCNT	added (for LoRaWAN V1.1)	READ:PROTOCOL:UPDATE_NFCNT?	added (for LoRaWAN V1.1)	CONF:PROTOCOL:UPDATE_AFCNT	added (for LoRaWAN V1.1)	READ:PROTOCOL:UPDATE_AFCNT?	added (for LoRaWAN V1.1)	CONF:PROTOCOL:JOIN_EUI	added (for LoRaWAN V1.1)	READ:PROTOCOL:JOIN_EUI?	added (for LoRaWAN V1.1)	Commands for LINK		CONF:LINK:MIC_ERR_DISPLAY	added	READ:LINK:MIC_ERR_DISPLAY?	added	CONF:LINK:SET_TM_AT_OTAA	added	READ:LINK:SET_TM_AT_OTAA?	added	CONF:LINK:SET_CH_AT_OTAA	added
Commands for RF Parameters																																																																																						
READ:RF:UL_CH?	added (n=0,1,...,7)																																																																																					
READ:RF:DL_CH?	added (n=0,1,...,7)																																																																																					
Commands for Protocol Parameter																																																																																						
CONF:PROTOCOL:DOWNLINK_SLOT	renamed from ...RX_WINDOW																																																																																					
READ:PROTOCOL:DOWNLINK_SLOT?	renamed from ...RX_WINDOW?																																																																																					
CONF:PROTOCOL:NETWORK	renamed from ...SYNC_WORD																																																																																					
READ:PROTOCOL:NETWORK?	renamed from ...SYNC_WORD?																																																																																					
CONF:PROTOCOL:UPLINK_DR	renamed from ...UL_DR																																																																																					
READ:PROTOCOL:UPLINK_DR?	renamed from ...UL_DR?																																																																																					
CONF:PROTOCOL:UPDATE_FCNT	added																																																																																					
READ:PROTOCOL:UPDATE_FCNT?	added																																																																																					
CONF:PROTOCOL:PING_PERIODICITY	added																																																																																					
READ:PROTOCOL:PING_PERIODICITY?	added																																																																																					
CONF:PROTOCOL:PROTOCOL_VER	added																																																																																					
READ:PROTOCOL:PROTOCOL_VER?	added																																																																																					
CONF:PROTOCOL:NWK_KEY	added (for LoRaWAN V1.1)																																																																																					
READ:PROTOCOL:NWK_KEY?	added (for LoRaWAN V1.1)																																																																																					
CONF:PROTOCOL:FNWKS_IKEY	added (for LoRaWAN V1.1)																																																																																					
READ:PROTOCOL:FNWKS_IKEY?	added (for LoRaWAN V1.1)																																																																																					
CONF:PROTOCOL:SNWKS_IKEY	added (for LoRaWAN V1.1)																																																																																					
READ:PROTOCOL:SNWKS_IKEY?	added (for LoRaWAN V1.1)																																																																																					
CONF:PROTOCOL:NWKS_EKEY	added (for LoRaWAN V1.1)																																																																																					
READ:PROTOCOL:NWKS_EKEY?	added (for LoRaWAN V1.1)																																																																																					
READ:PROTOCOL:DL_DWELL_TIME?	added																																																																																					
READ:PROTOCOL:UL_DWELL_TIME?	added																																																																																					
CONF:PROTOCOL:LATITUDE	added																																																																																					
READ:PROTOCOL:LATITUDE?	added																																																																																					
CONF:PROTOCOL:LONGITUDE	added																																																																																					
READ:PROTOCOL:LONGITUDE?	added																																																																																					
CONF:PROTOCOL:UPDATE_NFCNT	added (for LoRaWAN V1.1)																																																																																					
READ:PROTOCOL:UPDATE_NFCNT?	added (for LoRaWAN V1.1)																																																																																					
CONF:PROTOCOL:UPDATE_AFCNT	added (for LoRaWAN V1.1)																																																																																					
READ:PROTOCOL:UPDATE_AFCNT?	added (for LoRaWAN V1.1)																																																																																					
CONF:PROTOCOL:JOIN_EUI	added (for LoRaWAN V1.1)																																																																																					
READ:PROTOCOL:JOIN_EUI?	added (for LoRaWAN V1.1)																																																																																					
Commands for LINK																																																																																						
CONF:LINK:MIC_ERR_DISPLAY	added																																																																																					
READ:LINK:MIC_ERR_DISPLAY?	added																																																																																					
CONF:LINK:SET_TM_AT_OTAA	added																																																																																					
READ:LINK:SET_TM_AT_OTAA?	added																																																																																					
CONF:LINK:SET_CH_AT_OTAA	added																																																																																					

		<table border="1"> <tr><td>READ:LINK:SET_CH_AT_OTAA?</td><td>added</td></tr> <tr><td>CONF:LINK:REJOIN_DR</td><td>added (for LoRaWAN V1.1)</td></tr> <tr><td>READ:LINK:REJOIN_DR?</td><td>added (for LoRaWAN V1.1)</td></tr> <tr><td>CONF:LINK:REJOIN_TYPE</td><td>added (for LoRaWAN V1.1)</td></tr> <tr><td>READ:LINK:REJOIN_TYPE?</td><td>added (for LoRaWAN V1.1)</td></tr> <tr><td>CONF:LINK:REJOIN_RETRY</td><td>added (for LoRaWAN V1.1)</td></tr> <tr><td>READ:LINK:REJOIN_RETRY?</td><td>added (for LoRaWAN V1.1)</td></tr> <tr><td>CONF:LINK:REJOIN_PERIOD</td><td>added (for LoRaWAN V1.1)</td></tr> <tr><td>READ:LINK:REJOIN_PERIOD?</td><td>added (for LoRaWAN V1.1)</td></tr> <tr><td>CONF:LINK:REJOIN_MAX_TIME_N</td><td>added (for LoRaWAN V1.1)</td></tr> <tr><td>READ:LINK:REJOIN_MAX_TIME_N?</td><td>added (for LoRaWAN V1.1)</td></tr> <tr><td>CONF:LINK:REJOIN_MAX_CNT_N</td><td>added (for LoRaWAN V1.1)</td></tr> <tr><td>READ:LINK:REJOIN_MAX_CNT_N?</td><td>added (for LoRaWAN V1.1)</td></tr> <tr><td>CONF:LINK:ADR_LIMIT_EXP</td><td>added (for LoRaWAN V1.1)</td></tr> <tr><td>READ:LINK:ADR_LIMIT_EXP?</td><td>added (for LoRaWAN V1.1)</td></tr> <tr><td>CONF:LINK:ADR_DELAY_EXP</td><td>added (for LoRaWAN V1.1)</td></tr> <tr><td>READ:LINK:ADR_DELAY_EXP?</td><td>added (for LoRaWAN V1.1)</td></tr> <tr><td>CONF:LINK:PING_FREQ</td><td>added</td></tr> <tr><td>READ:LINK:PING_FREQ?</td><td>added</td></tr> <tr><td>CONF:LINK:PING_DR</td><td>added</td></tr> <tr><td>READ:LINK:PING_DR?</td><td>added</td></tr> <tr><td>CONF:LINK:BEACON_FREQ</td><td>added</td></tr> <tr><td>READ:LINK:BEACON_FREQ?</td><td>added</td></tr> <tr><td>CONF:LINK:BEACON_DR</td><td>added</td></tr> <tr><td>READ:LINK:BEACON_DR?</td><td>added</td></tr> <tr><td colspan="2">Commands for SENSITIVITY</td></tr> <tr><td>CONF:SENSITIVITY:DOWNLINK_SLOT</td><td>renamed from ...RX_WINDOW</td></tr> <tr><td>READ:SENSITIVITY:DOWNLINK_SLOT?</td><td>renamed from ...RX_WINDOW?</td></tr> <tr><td colspan="2">Commands for NST</td></tr> <tr><td>CONF:NST:TX:NETWORK</td><td>renamed from ...SYNC_WORD</td></tr> <tr><td>READ:NST:TX:NETWORK?</td><td>renamed from ...SYNC_WORD?</td></tr> <tr><td>CONF:NST:RX:NETWORK</td><td>renamed from ...SYNC_WORD</td></tr> <tr><td>READ:NST:RX:NETWORK?</td><td>renamed from ...SYNC_WORD?</td></tr> <tr><td>CONF:NST:TX:IQ_POLARITY</td><td>deleted</td></tr> <tr><td>READ:NST:TX:IQ_POLARITY?</td><td>deleted</td></tr> <tr><td>CONF:NST:RX:IQ_POLARITY</td><td>deleted</td></tr> <tr><td>READ:NST:RX:IQ_POLARITY?</td><td>deleted</td></tr> </table>	READ:LINK:SET_CH_AT_OTAA?	added	CONF:LINK:REJOIN_DR	added (for LoRaWAN V1.1)	READ:LINK:REJOIN_DR?	added (for LoRaWAN V1.1)	CONF:LINK:REJOIN_TYPE	added (for LoRaWAN V1.1)	READ:LINK:REJOIN_TYPE?	added (for LoRaWAN V1.1)	CONF:LINK:REJOIN_RETRY	added (for LoRaWAN V1.1)	READ:LINK:REJOIN_RETRY?	added (for LoRaWAN V1.1)	CONF:LINK:REJOIN_PERIOD	added (for LoRaWAN V1.1)	READ:LINK:REJOIN_PERIOD?	added (for LoRaWAN V1.1)	CONF:LINK:REJOIN_MAX_TIME_N	added (for LoRaWAN V1.1)	READ:LINK:REJOIN_MAX_TIME_N?	added (for LoRaWAN V1.1)	CONF:LINK:REJOIN_MAX_CNT_N	added (for LoRaWAN V1.1)	READ:LINK:REJOIN_MAX_CNT_N?	added (for LoRaWAN V1.1)	CONF:LINK:ADR_LIMIT_EXP	added (for LoRaWAN V1.1)	READ:LINK:ADR_LIMIT_EXP?	added (for LoRaWAN V1.1)	CONF:LINK:ADR_DELAY_EXP	added (for LoRaWAN V1.1)	READ:LINK:ADR_DELAY_EXP?	added (for LoRaWAN V1.1)	CONF:LINK:PING_FREQ	added	READ:LINK:PING_FREQ?	added	CONF:LINK:PING_DR	added	READ:LINK:PING_DR?	added	CONF:LINK:BEACON_FREQ	added	READ:LINK:BEACON_FREQ?	added	CONF:LINK:BEACON_DR	added	READ:LINK:BEACON_DR?	added	Commands for SENSITIVITY		CONF:SENSITIVITY:DOWNLINK_SLOT	renamed from ...RX_WINDOW	READ:SENSITIVITY:DOWNLINK_SLOT?	renamed from ...RX_WINDOW?	Commands for NST		CONF:NST:TX:NETWORK	renamed from ...SYNC_WORD	READ:NST:TX:NETWORK?	renamed from ...SYNC_WORD?	CONF:NST:RX:NETWORK	renamed from ...SYNC_WORD	READ:NST:RX:NETWORK?	renamed from ...SYNC_WORD?	CONF:NST:TX:IQ_POLARITY	deleted	READ:NST:TX:IQ_POLARITY?	deleted	CONF:NST:RX:IQ_POLARITY	deleted	READ:NST:RX:IQ_POLARITY?	deleted
READ:LINK:SET_CH_AT_OTAA?	added																																																																											
CONF:LINK:REJOIN_DR	added (for LoRaWAN V1.1)																																																																											
READ:LINK:REJOIN_DR?	added (for LoRaWAN V1.1)																																																																											
CONF:LINK:REJOIN_TYPE	added (for LoRaWAN V1.1)																																																																											
READ:LINK:REJOIN_TYPE?	added (for LoRaWAN V1.1)																																																																											
CONF:LINK:REJOIN_RETRY	added (for LoRaWAN V1.1)																																																																											
READ:LINK:REJOIN_RETRY?	added (for LoRaWAN V1.1)																																																																											
CONF:LINK:REJOIN_PERIOD	added (for LoRaWAN V1.1)																																																																											
READ:LINK:REJOIN_PERIOD?	added (for LoRaWAN V1.1)																																																																											
CONF:LINK:REJOIN_MAX_TIME_N	added (for LoRaWAN V1.1)																																																																											
READ:LINK:REJOIN_MAX_TIME_N?	added (for LoRaWAN V1.1)																																																																											
CONF:LINK:REJOIN_MAX_CNT_N	added (for LoRaWAN V1.1)																																																																											
READ:LINK:REJOIN_MAX_CNT_N?	added (for LoRaWAN V1.1)																																																																											
CONF:LINK:ADR_LIMIT_EXP	added (for LoRaWAN V1.1)																																																																											
READ:LINK:ADR_LIMIT_EXP?	added (for LoRaWAN V1.1)																																																																											
CONF:LINK:ADR_DELAY_EXP	added (for LoRaWAN V1.1)																																																																											
READ:LINK:ADR_DELAY_EXP?	added (for LoRaWAN V1.1)																																																																											
CONF:LINK:PING_FREQ	added																																																																											
READ:LINK:PING_FREQ?	added																																																																											
CONF:LINK:PING_DR	added																																																																											
READ:LINK:PING_DR?	added																																																																											
CONF:LINK:BEACON_FREQ	added																																																																											
READ:LINK:BEACON_FREQ?	added																																																																											
CONF:LINK:BEACON_DR	added																																																																											
READ:LINK:BEACON_DR?	added																																																																											
Commands for SENSITIVITY																																																																												
CONF:SENSITIVITY:DOWNLINK_SLOT	renamed from ...RX_WINDOW																																																																											
READ:SENSITIVITY:DOWNLINK_SLOT?	renamed from ...RX_WINDOW?																																																																											
Commands for NST																																																																												
CONF:NST:TX:NETWORK	renamed from ...SYNC_WORD																																																																											
READ:NST:TX:NETWORK?	renamed from ...SYNC_WORD?																																																																											
CONF:NST:RX:NETWORK	renamed from ...SYNC_WORD																																																																											
READ:NST:RX:NETWORK?	renamed from ...SYNC_WORD?																																																																											
CONF:NST:TX:IQ_POLARITY	deleted																																																																											
READ:NST:TX:IQ_POLARITY?	deleted																																																																											
CONF:NST:RX:IQ_POLARITY	deleted																																																																											
READ:NST:RX:IQ_POLARITY?	deleted																																																																											
V1.05	2017.09.26	<p>- Firmware version: V1.05 - Added or renamed remote commands. See 4.4 for details.</p> <table border="1"> <tr><td colspan="2">Commands for RF Parameters</td></tr> <tr><td>CONF:RF:FREQ_OFFSET</td><td>added</td></tr> <tr><td>READ:RF:FREQ_OFFSET?</td><td>added</td></tr> <tr><td>CONF:RF:TIME_OFFSET</td><td></td></tr> <tr><td>READ:RF:TIME_OFFSET?</td><td></td></tr> <tr><td>CONF:RF:CH_MASK_n</td><td>added (n=0,1,...,5)</td></tr> <tr><td>READ:RF:CH_MASK_n?</td><td>added</td></tr> <tr><td>CONF:RF:CH_GROUP_A</td><td>added</td></tr> <tr><td>READ:RF:CH_GROUP_A?</td><td>added</td></tr> <tr><td>CONF:RF:CH_GROUP_B</td><td>added</td></tr> <tr><td>READ:RF:CH_GROUP_B?</td><td>added</td></tr> <tr><td>CONF:RF:CH_n</td><td>deleted (n=0,1,...,7)</td></tr> <tr><td>READ:RF:CH_n?</td><td>deleted</td></tr> <tr><td>CONF:RF:UL_CH_n</td><td>deleted (n=0,1,...,7)</td></tr> <tr><td>READ:RF:UL_CH_n?</td><td>deleted</td></tr> <tr><td>CONF:RF:DL_CH_n</td><td>deleted (n=0,1,...,7)</td></tr> <tr><td>READ:RF:DL_CH_n?</td><td>deleted</td></tr> <tr><td colspan="2">Commands for Protocol Parameter</td></tr> <tr><td>CONF:PROTOCOL:RX_WINDOW</td><td>renamed from CONF:RF:RX_WINDOW</td></tr> <tr><td>READ:PROTOCOL:RX_WINDOW?</td><td>renamed from READ:RF:RX_WINDOW?</td></tr> <tr><td>CONF:PROTOCOL:RX1_DR_OFFSET</td><td>renamed from CONF:LINK:RX1_DR_OFFSET</td></tr> <tr><td>READ:PROTOCOL:RX1_DR_OFFSET?</td><td>renamed from READ:LINK:RX1_DR_OFFSET?</td></tr> <tr><td>CONF:PROTOCOL:RX2_FREQ</td><td>renamed from CONF:LINK:RX2_FREQ</td></tr> <tr><td>READ:PROTOCOL:RX2_FREQ?</td><td>renamed from READ:LINK:RX2_FREQ?</td></tr> <tr><td>CONF:PROTOCOL:RX2_DR</td><td>renamed from CONF:LINK:RX2_DR</td></tr> <tr><td>READ:PROTOCOL:RX2_DR?</td><td>renamed from READ:LINK:RX2_DR?</td></tr> </table>	Commands for RF Parameters		CONF:RF:FREQ_OFFSET	added	READ:RF:FREQ_OFFSET?	added	CONF:RF:TIME_OFFSET		READ:RF:TIME_OFFSET?		CONF:RF:CH_MASK_n	added (n=0,1,...,5)	READ:RF:CH_MASK_n?	added	CONF:RF:CH_GROUP_A	added	READ:RF:CH_GROUP_A?	added	CONF:RF:CH_GROUP_B	added	READ:RF:CH_GROUP_B?	added	CONF:RF:CH_n	deleted (n=0,1,...,7)	READ:RF:CH_n?	deleted	CONF:RF:UL_CH_n	deleted (n=0,1,...,7)	READ:RF:UL_CH_n?	deleted	CONF:RF:DL_CH_n	deleted (n=0,1,...,7)	READ:RF:DL_CH_n?	deleted	Commands for Protocol Parameter		CONF:PROTOCOL:RX_WINDOW	renamed from CONF:RF:RX_WINDOW	READ:PROTOCOL:RX_WINDOW?	renamed from READ:RF:RX_WINDOW?	CONF:PROTOCOL:RX1_DR_OFFSET	renamed from CONF:LINK:RX1_DR_OFFSET	READ:PROTOCOL:RX1_DR_OFFSET?	renamed from READ:LINK:RX1_DR_OFFSET?	CONF:PROTOCOL:RX2_FREQ	renamed from CONF:LINK:RX2_FREQ	READ:PROTOCOL:RX2_FREQ?	renamed from READ:LINK:RX2_FREQ?	CONF:PROTOCOL:RX2_DR	renamed from CONF:LINK:RX2_DR	READ:PROTOCOL:RX2_DR?	renamed from READ:LINK:RX2_DR?																						
Commands for RF Parameters																																																																												
CONF:RF:FREQ_OFFSET	added																																																																											
READ:RF:FREQ_OFFSET?	added																																																																											
CONF:RF:TIME_OFFSET																																																																												
READ:RF:TIME_OFFSET?																																																																												
CONF:RF:CH_MASK_n	added (n=0,1,...,5)																																																																											
READ:RF:CH_MASK_n?	added																																																																											
CONF:RF:CH_GROUP_A	added																																																																											
READ:RF:CH_GROUP_A?	added																																																																											
CONF:RF:CH_GROUP_B	added																																																																											
READ:RF:CH_GROUP_B?	added																																																																											
CONF:RF:CH_n	deleted (n=0,1,...,7)																																																																											
READ:RF:CH_n?	deleted																																																																											
CONF:RF:UL_CH_n	deleted (n=0,1,...,7)																																																																											
READ:RF:UL_CH_n?	deleted																																																																											
CONF:RF:DL_CH_n	deleted (n=0,1,...,7)																																																																											
READ:RF:DL_CH_n?	deleted																																																																											
Commands for Protocol Parameter																																																																												
CONF:PROTOCOL:RX_WINDOW	renamed from CONF:RF:RX_WINDOW																																																																											
READ:PROTOCOL:RX_WINDOW?	renamed from READ:RF:RX_WINDOW?																																																																											
CONF:PROTOCOL:RX1_DR_OFFSET	renamed from CONF:LINK:RX1_DR_OFFSET																																																																											
READ:PROTOCOL:RX1_DR_OFFSET?	renamed from READ:LINK:RX1_DR_OFFSET?																																																																											
CONF:PROTOCOL:RX2_FREQ	renamed from CONF:LINK:RX2_FREQ																																																																											
READ:PROTOCOL:RX2_FREQ?	renamed from READ:LINK:RX2_FREQ?																																																																											
CONF:PROTOCOL:RX2_DR	renamed from CONF:LINK:RX2_DR																																																																											
READ:PROTOCOL:RX2_DR?	renamed from READ:LINK:RX2_DR?																																																																											

		<table border="1"> <tr> <td>CONF:PROTOCOL:UL_DR</td> <td>renamed from CONF:RF:UL_DR</td> </tr> <tr> <td>READ:PROTOCOL:UL_DR?</td> <td>renamed from READ:RF:UL_DR?</td> </tr> <tr> <td colspan="2">Commands for LINK</td> </tr> <tr> <td>CONF:LINK:MAC_CMD_TYPE</td> <td>added</td> </tr> <tr> <td>READ:LINK:MAC_CMD_TYPE?</td> <td>added</td> </tr> <tr> <td>CONF:LINK:MAC_CMD_FIELD</td> <td>added</td> </tr> <tr> <td>READ:LINK:MAC_CMD_FIELD?</td> <td>added</td> </tr> <tr> <td>CONF:LINK:NUM_OF_CMD</td> <td>added</td> </tr> <tr> <td>READ:LINK:NUM_OF_CMD?</td> <td>added</td> </tr> <tr> <td>CONF:LINK:DL_CH_INDEX</td> <td>added</td> </tr> <tr> <td>READ:LINK:DL_CH_INDEX?</td> <td>added</td> </tr> <tr> <td>CONF:LINK:DL_CH_FREQ</td> <td>added</td> </tr> <tr> <td>READ:LINK:DL_CH_FREQ?</td> <td>added</td> </tr> <tr> <td colspan="2">Commands for POW_TIME & POW_CH</td> </tr> <tr> <td>READ:POWER:ALL:NUM?</td> <td>added</td> </tr> <tr> <td>READ:POWER:SF7:NUM?</td> <td>added</td> </tr> <tr> <td>READ:POWER:SF8:NUM?</td> <td>added</td> </tr> <tr> <td>READ:POWER:SF9:NUM?</td> <td>added</td> </tr> <tr> <td>READ:POWER:SF10:NUM?</td> <td>added</td> </tr> <tr> <td>READ:POWER:SF11:NUM?</td> <td>added</td> </tr> <tr> <td>READ:POWER:SF12:NUM?</td> <td>added</td> </tr> <tr> <td>READ:POWER:CH_0:NUM?</td> <td>added</td> </tr> <tr> <td>READ:POWER:CH_1:NUM?</td> <td>added</td> </tr> <tr> <td>READ:POWER:CH_2:NUM?</td> <td>added</td> </tr> <tr> <td>READ:POWER:CH_3:NUM?</td> <td>added</td> </tr> <tr> <td>READ:POWER:CH_4:NUM?</td> <td>added</td> </tr> <tr> <td>READ:POWER:CH_5:NUM?</td> <td>added</td> </tr> <tr> <td>READ:POWER:CH_6:NUM?</td> <td>added</td> </tr> <tr> <td>READ:POWER:CH_7:NUM?</td> <td>added</td> </tr> <tr> <td>READ:POWER:RX2:NUM?</td> <td>added</td> </tr> <tr> <td>READ:POWER:RX2:MAX?</td> <td>added</td> </tr> <tr> <td>READ:POWER:RX2:AVG?</td> <td>added</td> </tr> <tr> <td>READ:POWER:RX2:MIN?</td> <td>added</td> </tr> <tr> <td colspan="2">Commands for SENSITIVITY</td> </tr> <tr> <td>CONF:SENSITIVITY:NUM_POW</td> <td>added</td> </tr> <tr> <td>READ:SENSITIVITY:NUM_POW?</td> <td>added</td> </tr> <tr> <td>CONF:SENSITIVITY:STEP_NUM</td> <td>deleted</td> </tr> <tr> <td>READ:SENSITIVITY:STEP_NUM?</td> <td>deleted</td> </tr> <tr> <td>CONF:SENSITIVITY:SET_SF_AT_START</td> <td>renamed from SET_DR_AT_START</td> </tr> <tr> <td>READ:SENSITIVITY:SET_SF_AT_START?</td> <td>renamed from SET_DR_AT_START?</td> </tr> <tr> <td>CONF:SENSITIVITY:SF</td> <td>renamed from CONF:SENSITIVITY:DR</td> </tr> <tr> <td>READ:SENSITIVITY:SF?</td> <td>renamed from READ:SENSITIVITY:SF?</td> </tr> <tr> <td>CONF:SENSITIVITY:FPORT</td> <td>added</td> </tr> <tr> <td>READ:SENSITIVITY:FPORT?</td> <td>added</td> </tr> <tr> <td>CONF:SENSITIVITY:PAYLOAD_SIZE</td> <td>added</td> </tr> <tr> <td>READ:SENSITIVITY:PAYLOAD_SIZE?</td> <td>added</td> </tr> <tr> <td>CONF:SENSITIVITY:PAYLOAD</td> <td>added</td> </tr> <tr> <td>READ:SENSITIVITY:PAYLOAD?</td> <td>added</td> </tr> <tr> <td colspan="2">Commands for NST</td> </tr> <tr> <td>CONF:NST:TX:SYNC_WORD</td> <td>added</td> </tr> <tr> <td>READ:NST:TX:SYNC_WORD?</td> <td>added</td> </tr> <tr> <td>CONF:NST:RX:SYNC_WORD</td> <td>added</td> </tr> <tr> <td>READ:NST:RX:SYNC_WORD?</td> <td>added</td> </tr> <tr> <td>READ:NST:RX:POW_NUM?</td> <td>added</td> </tr> <tr> <td>READ:NST:RX:POW_MAX?</td> <td>added</td> </tr> <tr> <td>READ:NST:RX:POW_AVG?</td> <td>added</td> </tr> <tr> <td>READ:NST:RX:POW_MIN?</td> <td>added</td> </tr> </table>	CONF:PROTOCOL:UL_DR	renamed from CONF:RF:UL_DR	READ:PROTOCOL:UL_DR?	renamed from READ:RF:UL_DR?	Commands for LINK		CONF:LINK:MAC_CMD_TYPE	added	READ:LINK:MAC_CMD_TYPE?	added	CONF:LINK:MAC_CMD_FIELD	added	READ:LINK:MAC_CMD_FIELD?	added	CONF:LINK:NUM_OF_CMD	added	READ:LINK:NUM_OF_CMD?	added	CONF:LINK:DL_CH_INDEX	added	READ:LINK:DL_CH_INDEX?	added	CONF:LINK:DL_CH_FREQ	added	READ:LINK:DL_CH_FREQ?	added	Commands for POW_TIME & POW_CH		READ:POWER:ALL:NUM?	added	READ:POWER:SF7:NUM?	added	READ:POWER:SF8:NUM?	added	READ:POWER:SF9:NUM?	added	READ:POWER:SF10:NUM?	added	READ:POWER:SF11:NUM?	added	READ:POWER:SF12:NUM?	added	READ:POWER:CH_0:NUM?	added	READ:POWER:CH_1:NUM?	added	READ:POWER:CH_2:NUM?	added	READ:POWER:CH_3:NUM?	added	READ:POWER:CH_4:NUM?	added	READ:POWER:CH_5:NUM?	added	READ:POWER:CH_6:NUM?	added	READ:POWER:CH_7:NUM?	added	READ:POWER:RX2:NUM?	added	READ:POWER:RX2:MAX?	added	READ:POWER:RX2:AVG?	added	READ:POWER:RX2:MIN?	added	Commands for SENSITIVITY		CONF:SENSITIVITY:NUM_POW	added	READ:SENSITIVITY:NUM_POW?	added	CONF:SENSITIVITY:STEP_NUM	deleted	READ:SENSITIVITY:STEP_NUM?	deleted	CONF:SENSITIVITY:SET_SF_AT_START	renamed from SET_DR_AT_START	READ:SENSITIVITY:SET_SF_AT_START?	renamed from SET_DR_AT_START?	CONF:SENSITIVITY:SF	renamed from CONF:SENSITIVITY:DR	READ:SENSITIVITY:SF?	renamed from READ:SENSITIVITY:SF?	CONF:SENSITIVITY:FPORT	added	READ:SENSITIVITY:FPORT?	added	CONF:SENSITIVITY:PAYLOAD_SIZE	added	READ:SENSITIVITY:PAYLOAD_SIZE?	added	CONF:SENSITIVITY:PAYLOAD	added	READ:SENSITIVITY:PAYLOAD?	added	Commands for NST		CONF:NST:TX:SYNC_WORD	added	READ:NST:TX:SYNC_WORD?	added	CONF:NST:RX:SYNC_WORD	added	READ:NST:RX:SYNC_WORD?	added	READ:NST:RX:POW_NUM?	added	READ:NST:RX:POW_MAX?	added	READ:NST:RX:POW_AVG?	added	READ:NST:RX:POW_MIN?	added
CONF:PROTOCOL:UL_DR	renamed from CONF:RF:UL_DR																																																																																																																			
READ:PROTOCOL:UL_DR?	renamed from READ:RF:UL_DR?																																																																																																																			
Commands for LINK																																																																																																																				
CONF:LINK:MAC_CMD_TYPE	added																																																																																																																			
READ:LINK:MAC_CMD_TYPE?	added																																																																																																																			
CONF:LINK:MAC_CMD_FIELD	added																																																																																																																			
READ:LINK:MAC_CMD_FIELD?	added																																																																																																																			
CONF:LINK:NUM_OF_CMD	added																																																																																																																			
READ:LINK:NUM_OF_CMD?	added																																																																																																																			
CONF:LINK:DL_CH_INDEX	added																																																																																																																			
READ:LINK:DL_CH_INDEX?	added																																																																																																																			
CONF:LINK:DL_CH_FREQ	added																																																																																																																			
READ:LINK:DL_CH_FREQ?	added																																																																																																																			
Commands for POW_TIME & POW_CH																																																																																																																				
READ:POWER:ALL:NUM?	added																																																																																																																			
READ:POWER:SF7:NUM?	added																																																																																																																			
READ:POWER:SF8:NUM?	added																																																																																																																			
READ:POWER:SF9:NUM?	added																																																																																																																			
READ:POWER:SF10:NUM?	added																																																																																																																			
READ:POWER:SF11:NUM?	added																																																																																																																			
READ:POWER:SF12:NUM?	added																																																																																																																			
READ:POWER:CH_0:NUM?	added																																																																																																																			
READ:POWER:CH_1:NUM?	added																																																																																																																			
READ:POWER:CH_2:NUM?	added																																																																																																																			
READ:POWER:CH_3:NUM?	added																																																																																																																			
READ:POWER:CH_4:NUM?	added																																																																																																																			
READ:POWER:CH_5:NUM?	added																																																																																																																			
READ:POWER:CH_6:NUM?	added																																																																																																																			
READ:POWER:CH_7:NUM?	added																																																																																																																			
READ:POWER:RX2:NUM?	added																																																																																																																			
READ:POWER:RX2:MAX?	added																																																																																																																			
READ:POWER:RX2:AVG?	added																																																																																																																			
READ:POWER:RX2:MIN?	added																																																																																																																			
Commands for SENSITIVITY																																																																																																																				
CONF:SENSITIVITY:NUM_POW	added																																																																																																																			
READ:SENSITIVITY:NUM_POW?	added																																																																																																																			
CONF:SENSITIVITY:STEP_NUM	deleted																																																																																																																			
READ:SENSITIVITY:STEP_NUM?	deleted																																																																																																																			
CONF:SENSITIVITY:SET_SF_AT_START	renamed from SET_DR_AT_START																																																																																																																			
READ:SENSITIVITY:SET_SF_AT_START?	renamed from SET_DR_AT_START?																																																																																																																			
CONF:SENSITIVITY:SF	renamed from CONF:SENSITIVITY:DR																																																																																																																			
READ:SENSITIVITY:SF?	renamed from READ:SENSITIVITY:SF?																																																																																																																			
CONF:SENSITIVITY:FPORT	added																																																																																																																			
READ:SENSITIVITY:FPORT?	added																																																																																																																			
CONF:SENSITIVITY:PAYLOAD_SIZE	added																																																																																																																			
READ:SENSITIVITY:PAYLOAD_SIZE?	added																																																																																																																			
CONF:SENSITIVITY:PAYLOAD	added																																																																																																																			
READ:SENSITIVITY:PAYLOAD?	added																																																																																																																			
Commands for NST																																																																																																																				
CONF:NST:TX:SYNC_WORD	added																																																																																																																			
READ:NST:TX:SYNC_WORD?	added																																																																																																																			
CONF:NST:RX:SYNC_WORD	added																																																																																																																			
READ:NST:RX:SYNC_WORD?	added																																																																																																																			
READ:NST:RX:POW_NUM?	added																																																																																																																			
READ:NST:RX:POW_MAX?	added																																																																																																																			
READ:NST:RX:POW_AVG?	added																																																																																																																			
READ:NST:RX:POW_MIN?	added																																																																																																																			
V1.04	2017.08.05	<ul style="list-style-type: none"> - Firmware version: V1.04 - Improved Sensitivity Test in EDT by providing two different test scenarios: one is to use periodic uplink frames of DUT and the other is to use Echo request after DUT is activated to test mode. - Added or renamed remote commands corresponding to transmission of MAC commands. See 4.4.4 and 4.4.5. <table border="1"> <tr> <td>CONF:RF:RX_WINDOW</td> <td>renamed from CONF:RF:DL_CH_OPTION</td> </tr> <tr> <td>READ:RF:RX_WINDOW?</td> <td>renamed from READ:RF:DL_CH_OPTION?</td> </tr> </table>	CONF:RF:RX_WINDOW	renamed from CONF:RF:DL_CH_OPTION	READ:RF:RX_WINDOW?	renamed from READ:RF:DL_CH_OPTION?																																																																																																														
CONF:RF:RX_WINDOW	renamed from CONF:RF:DL_CH_OPTION																																																																																																																			
READ:RF:RX_WINDOW?	renamed from READ:RF:DL_CH_OPTION?																																																																																																																			

		<table border="1"> <tr><td>READ:PROTOCOL:ACTIVATION STATUS?</td><td>added</td></tr> <tr><td>CONF:PROTOCOL:SYNC_WORD</td><td>added</td></tr> <tr><td>READ:PROTOCOL:SYNC_WORD?</td><td>added</td></tr> <tr><td>CONF:SENSITIVITY:SCENARIO</td><td>renamed from CONF:SENSITIVITY:MODE</td></tr> <tr><td>READ:SENSITIVITY:SCENARIO?</td><td>renamed from READ:SENSITIVITY:MODE?</td></tr> <tr><td>CONF:SENSITIVITY:PACKET_NUM</td><td>renamed from CONF:SENSITIVITY:REPEAT</td></tr> <tr><td>READ:SENSITIVITY:PACKET_NUM?</td><td>renamed from READ:SENSITIVITY:REPEAT?</td></tr> <tr><td>CONF:SENSITIVITY:RX_WINDOW</td><td>added</td></tr> <tr><td>READ:SENSITIVITY:RX_WINDOW?</td><td>added</td></tr> <tr><td>CONF:SENSITIVITY:DR</td><td>added</td></tr> <tr><td>READ:SENSITIVITY:DR?</td><td>added</td></tr> <tr><td>CONF:SENSITIVITY:SET_DR_AT_START</td><td>added</td></tr> <tr><td>READ:SENSITIVITY:SET_DR_AT_START?</td><td>added</td></tr> <tr><td>EXEC:NST:TX:RUN</td><td>added</td></tr> <tr><td>EXEC:NST:TX:STOP</td><td>added</td></tr> <tr><td>CONF:NST:TX:REPEAT_NUM</td><td>added</td></tr> <tr><td>READ:NST:TX:REPEAT_NUM?</td><td>added</td></tr> <tr><td>CONF:NST:TX:PAYLOAD</td><td>added</td></tr> <tr><td>READ:NST:TX:PAYLOAD?</td><td>added</td></tr> <tr><td>CONF:NST:TX:IQ_POLARITY</td><td>added</td></tr> <tr><td>READ:NST:TX:IQ_POLARITY?</td><td>added</td></tr> <tr><td>EXEC:NST:RX:RUN</td><td>added</td></tr> <tr><td>EXEC:NST:RX:STOP</td><td>added</td></tr> <tr><td>CONF:NST:RX:MODE</td><td>added</td></tr> <tr><td>READ:NST:RX:MODE?</td><td>added</td></tr> <tr><td>CONF:NST:RX:BW</td><td>added</td></tr> <tr><td>READ:NST:RX:BW?</td><td>added</td></tr> <tr><td>CONF:NST:RX:SF</td><td>added</td></tr> <tr><td>READ:NST:RX:SF?</td><td>added</td></tr> <tr><td>CONF:NST:RX:IQ_POLARITY</td><td>added</td></tr> <tr><td>READ:NST:RX:IQ_POLARITY?</td><td>added</td></tr> <tr><td colspan="2">All remote commands as to transmission of MAC commands were moved/renamed from PROTOCOL to LINK</td></tr> </table>	READ:PROTOCOL:ACTIVATION STATUS?	added	CONF:PROTOCOL:SYNC_WORD	added	READ:PROTOCOL:SYNC_WORD?	added	CONF:SENSITIVITY:SCENARIO	renamed from CONF:SENSITIVITY:MODE	READ:SENSITIVITY:SCENARIO?	renamed from READ:SENSITIVITY:MODE?	CONF:SENSITIVITY:PACKET_NUM	renamed from CONF:SENSITIVITY:REPEAT	READ:SENSITIVITY:PACKET_NUM?	renamed from READ:SENSITIVITY:REPEAT?	CONF:SENSITIVITY:RX_WINDOW	added	READ:SENSITIVITY:RX_WINDOW?	added	CONF:SENSITIVITY:DR	added	READ:SENSITIVITY:DR?	added	CONF:SENSITIVITY:SET_DR_AT_START	added	READ:SENSITIVITY:SET_DR_AT_START?	added	EXEC:NST:TX:RUN	added	EXEC:NST:TX:STOP	added	CONF:NST:TX:REPEAT_NUM	added	READ:NST:TX:REPEAT_NUM?	added	CONF:NST:TX:PAYLOAD	added	READ:NST:TX:PAYLOAD?	added	CONF:NST:TX:IQ_POLARITY	added	READ:NST:TX:IQ_POLARITY?	added	EXEC:NST:RX:RUN	added	EXEC:NST:RX:STOP	added	CONF:NST:RX:MODE	added	READ:NST:RX:MODE?	added	CONF:NST:RX:BW	added	READ:NST:RX:BW?	added	CONF:NST:RX:SF	added	READ:NST:RX:SF?	added	CONF:NST:RX:IQ_POLARITY	added	READ:NST:RX:IQ_POLARITY?	added	All remote commands as to transmission of MAC commands were moved/renamed from PROTOCOL to LINK	
READ:PROTOCOL:ACTIVATION STATUS?	added																																																																	
CONF:PROTOCOL:SYNC_WORD	added																																																																	
READ:PROTOCOL:SYNC_WORD?	added																																																																	
CONF:SENSITIVITY:SCENARIO	renamed from CONF:SENSITIVITY:MODE																																																																	
READ:SENSITIVITY:SCENARIO?	renamed from READ:SENSITIVITY:MODE?																																																																	
CONF:SENSITIVITY:PACKET_NUM	renamed from CONF:SENSITIVITY:REPEAT																																																																	
READ:SENSITIVITY:PACKET_NUM?	renamed from READ:SENSITIVITY:REPEAT?																																																																	
CONF:SENSITIVITY:RX_WINDOW	added																																																																	
READ:SENSITIVITY:RX_WINDOW?	added																																																																	
CONF:SENSITIVITY:DR	added																																																																	
READ:SENSITIVITY:DR?	added																																																																	
CONF:SENSITIVITY:SET_DR_AT_START	added																																																																	
READ:SENSITIVITY:SET_DR_AT_START?	added																																																																	
EXEC:NST:TX:RUN	added																																																																	
EXEC:NST:TX:STOP	added																																																																	
CONF:NST:TX:REPEAT_NUM	added																																																																	
READ:NST:TX:REPEAT_NUM?	added																																																																	
CONF:NST:TX:PAYLOAD	added																																																																	
READ:NST:TX:PAYLOAD?	added																																																																	
CONF:NST:TX:IQ_POLARITY	added																																																																	
READ:NST:TX:IQ_POLARITY?	added																																																																	
EXEC:NST:RX:RUN	added																																																																	
EXEC:NST:RX:STOP	added																																																																	
CONF:NST:RX:MODE	added																																																																	
READ:NST:RX:MODE?	added																																																																	
CONF:NST:RX:BW	added																																																																	
READ:NST:RX:BW?	added																																																																	
CONF:NST:RX:SF	added																																																																	
READ:NST:RX:SF?	added																																																																	
CONF:NST:RX:IQ_POLARITY	added																																																																	
READ:NST:RX:IQ_POLARITY?	added																																																																	
All remote commands as to transmission of MAC commands were moved/renamed from PROTOCOL to LINK																																																																		
V1.0	2017.06.05	Firmware version: V1.01 - First released																																																																

Appendix A - Basic Operation of RWC5020M

The Appendices describe the basic information and operation of RWC5020M.

- A.1. Front Panel View
- A.2. Rear Panel View
- A.3. Display Screen
- A.4. IP Type Selection
- A.5. IP Address Setting
- A.6. Firmware Upgrade
- A.7. Other Functions

A.1 Front Panel View

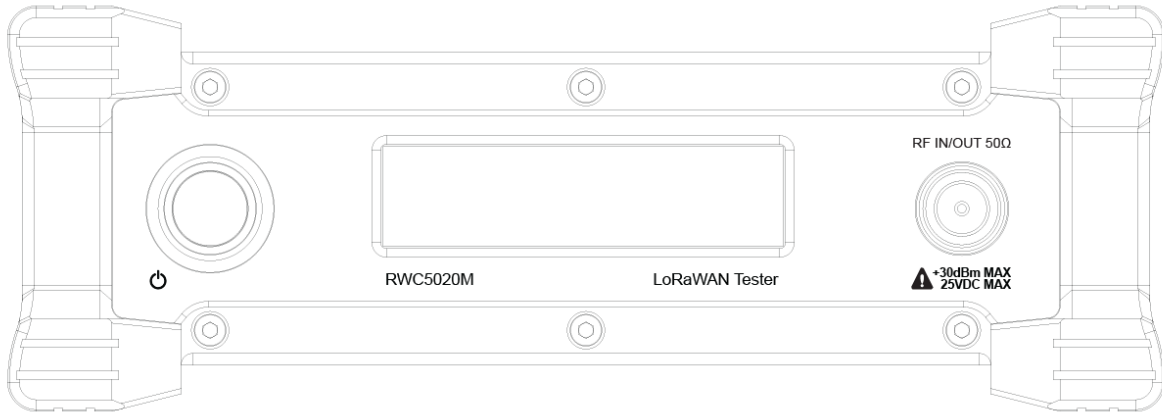







Fig A.1 RWC5020M Front Panel View

NO	Items	Names and Descriptions
1		2.8-inch OLED Display
2	 RF IN/OUT 50Ω 	RF IN/OUT Connectors
3	 	Power Switch

A.2 Rear Panel View

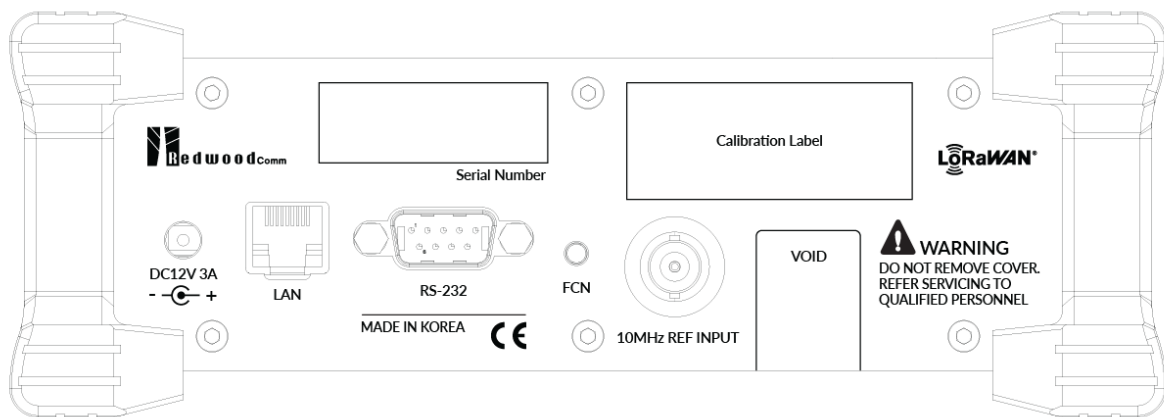

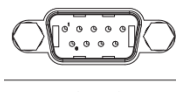

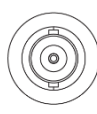

Fig A.2 RWC5020M Rear Panel View

NO	Items	Names and Descriptions
1	 DC12V 3A - - ⊕ +	DC12V/3A Adaptor Input
2	 LAN	Ethernet Interface
3	 RS-232C	RS-232C Interface
4	 FCN	FCN (Function) Key
5	 10MHz REF INPUT	10MHz External Reference Signal input

A.3 Display Screen

A.3.1 IDLE State Screen



Fig A.3 RWC5020M Screen in IDLE state

A.3.2 Running State Screen



Fig A.4 RWC5020M Screen in running state

A.4 IP Type Selection

IP_TYPE can be set to DYNAMIC or STATIC by pressing the FCN key on the rear panel or by sending a remote control command (CONF:SYSTEM:IP_TYPE) through the RS232C port. DYNAMIC means that the IP address can be obtained automatically from a DHCP server, and this configuration is recommended for RJ45 connections to network hubs. STATIC requires the user to manually configure the IP address, and this configuration is recommended for connecting the RWC5020M directly to a remote PC using a crossover cable.

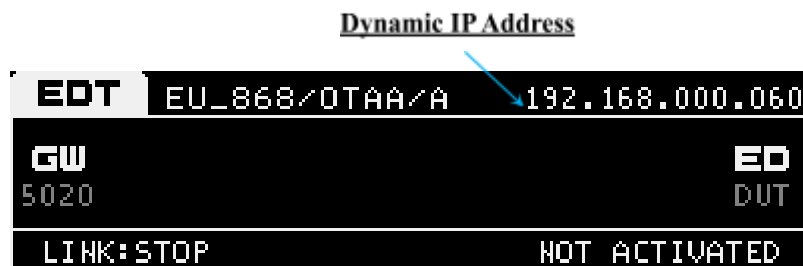

Fig A.5 RWC5020M Screen with Dynamic IP address

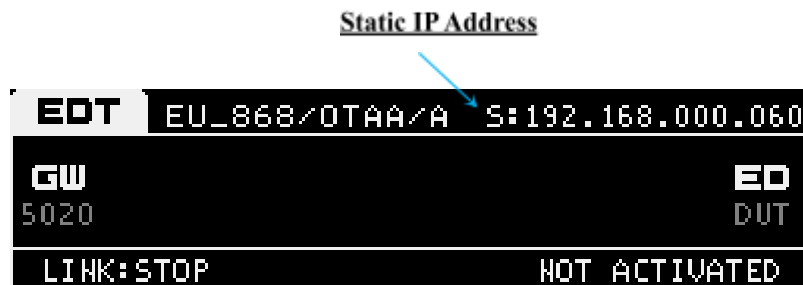

Fig A.6 RWC5020M Screen with Static IP address

A.5 IP Address Setting

IP_ADDRESS can be set to any value by sending a remote control command (CONF:SYSTEM:IP_ADDR) through the RS232C port.

A.6 Firmware Upgrade

As RWC5020M adapted Flash Memory, it is available to upgrade easily by using a remote PC without changing the hardware. For upgrading, 'RWC_Updater' program shall be used, which is provided together when the product is purchased or available to download the upgrade package including itself and the upgrade binary files from RedwoodComm Website (<http://www.redwoodcomm.com>). The information for upgrading shall be kept in providing to the user via email or website.

Normal Firmware Upgrade Procedure

- 1) Set up Ethernet connection between RWC5020M and a remote PC, using a RJ45 cable for normal connection to network hub or using a crossover cable for direct connection between them.
- 2) In case of direct connection using a crossover cable, IP configuration of a remote PC should be done manually as the following figure. The IP address of a remote PC shall be set to the same as that of RWC5020M except the last number.

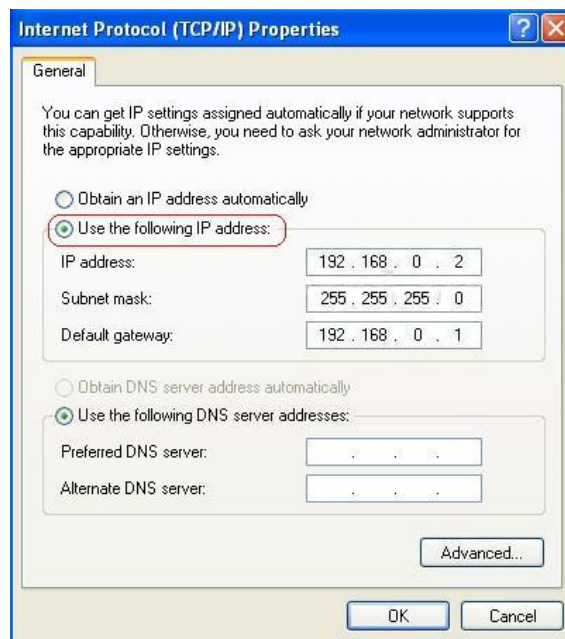

Fig A.7 IP configuration of a remote PC

CAUTION: For reliable upgrade, it is recommended to disable all other networks (e.g. WiFi, Virtual Machine) than Ethernet network in 'Change Adapter Settings' of a remote PC.

- 3) After downloading upgrade files from RedwoodComm website, execute an application program for upgrading.
- 4) Set up an IP address in the application program, and follow the instructions of the program.
- 5) During upgrading, RWC5020M may show the progressing information on its screen as the following figure.

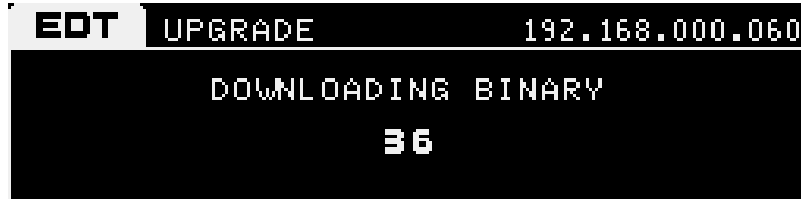

Fig A.8 Firmware Upgrade Screen

- 6) After upgrading completed, reboot RWC5020M and check the software version on the PC application program screen as follows.

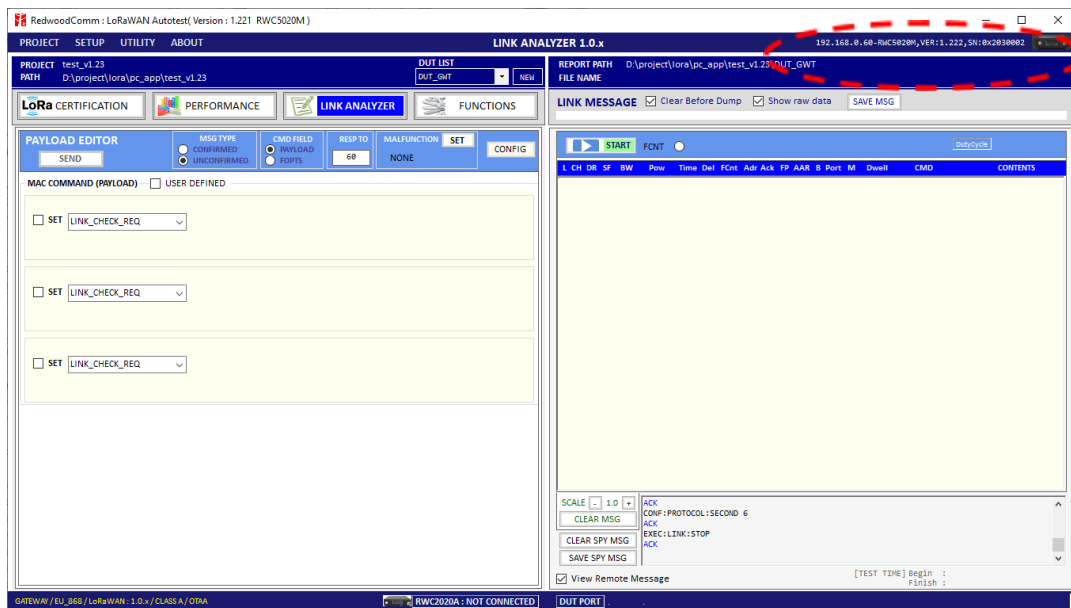

Fig A.9 PC Application Program

CAUTION: If upgrading fails, turn on RWC5020M in Emergency Upgrade Mode and upgrade firmware again. Refer to “Emergency Firmware Upgrade Procedure”.

Emergency Firmware Upgrade Procedure

- 1) If Normal Firmware Upgrade Procedure fails during upgrading, the internal memory may be damaged. In this case, RWC5020M may not boot correctly. Then RWC5020M must be upgraded in Emergency Upgrade Mode.
- 2) Turn off RWC5020M. While keeping the FCN key pressed, turn on RWC5020M. Then RWC5020M will boot in Emergency Upgrade Mode.
- 3) Make a direct connection between a remote PC and RWC5020M using a crossover cable and wait until the IP address of RWC5020M will be displayed on the screen.
- 4) Follow the steps 3) to 6) of the Normal Firmware Upgrade Procedure.

A.7 Other Functions

See the Application Program Manual for details.

Appendix B - Basic Operation of RWC5021P

The Appendices describe the basic information and operation of RWC5021P.

- B.1. Front Panel View
- B.2. Rear Panel View
- B.3. LED Indicator
- B.4. IP Type Selection and Address Setting
- B.5. Firmware Upgrade
- B.6. Other Functions

B.1 Front Panel View

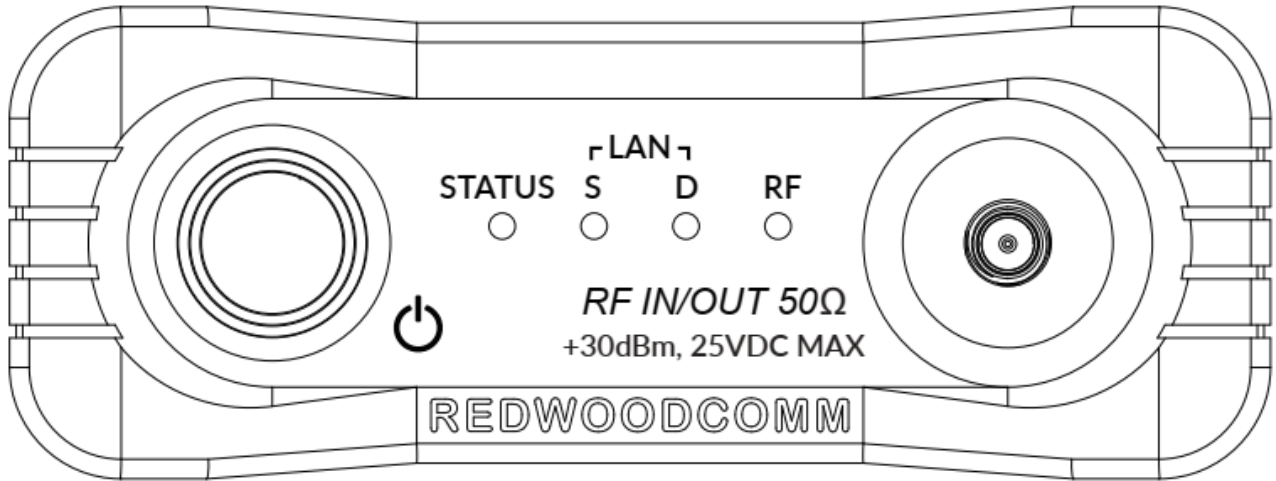





Fig B.1 RWC5021P Front Panel View

NO	Items	Names and Descriptions
1		LED indicator
2		RF IN/OUT Connectors
3		Power Switch

B.2 Rear Panel View

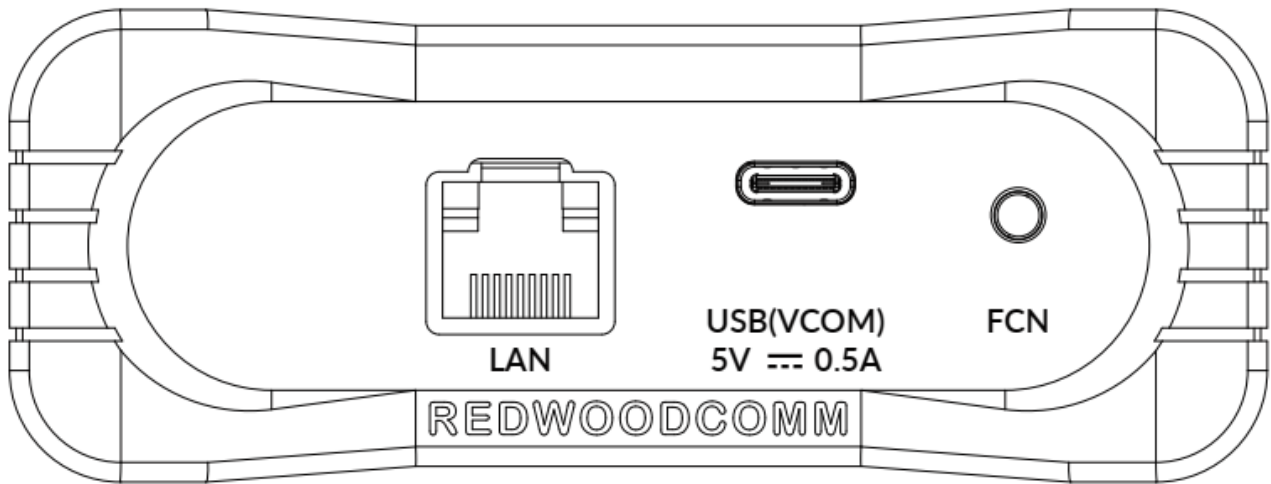





Fig B.2 RWC5021P Rear Panel View

NO	Items	Names and Descriptions
1	 LAN	Ethernet Interface
2		USB(VCOM) / Power Input
3	 FCN	FCN (Function) Key

B.3 LED Indicator

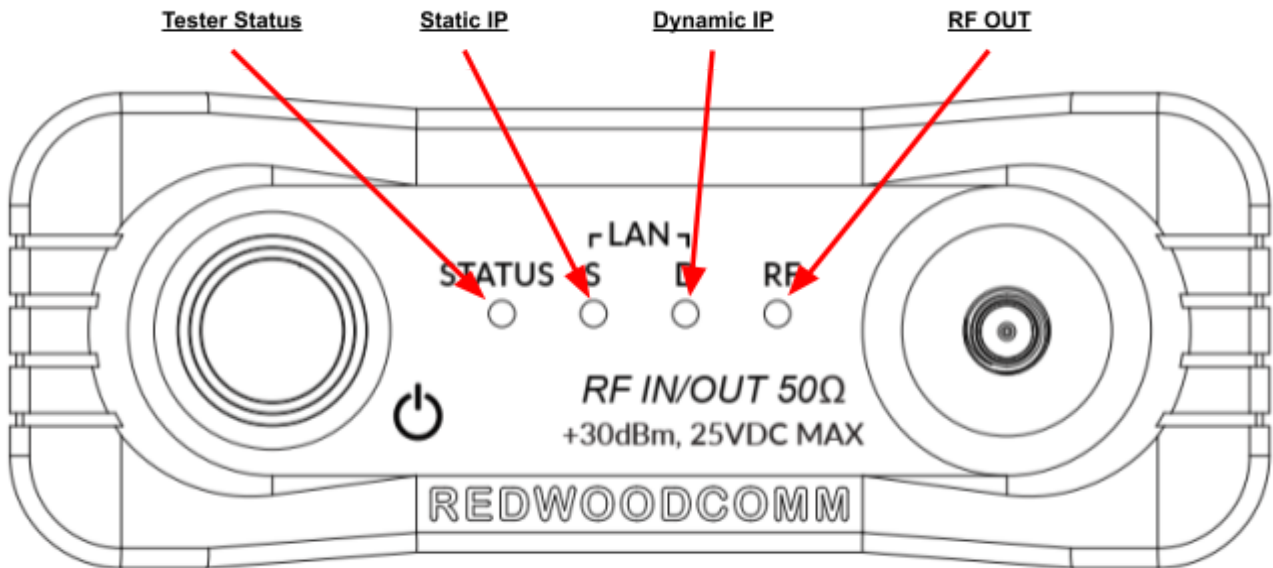

Fig B.3 RWC5021P LED indicator

Tester Status Indicator

This LED is flashing while RWC5021P is on and running with no serious issues

Static IP Indicator

This LED is on when Ethernet is connected via a static IP address.

Dynamic IP Indicator

This LED is on when Ethernet is connected via a dynamic IP address.

RF OUT Indicator

This LED is on when the RF out signal is being transmitted.

B.4 IP Type Selection and Address Setting

Because RWC5021P has no graphic display, users cannot recognize the currently set IP address and IP type directly. Users can find the currently set address and type of IP and change them easily using a terminal program like Teraterm or the RWC502x application.

In order to control RWC5021P, users have to connect RWC5021P to the user's PC first. Turn RWC5021P power ON, and open the VCOM port with a terminal program. In the case of Windows 10 OS, the USB Serial Port(COMx) driver will be installed automatically. If not, users have to install the driver(FTI chipset used)

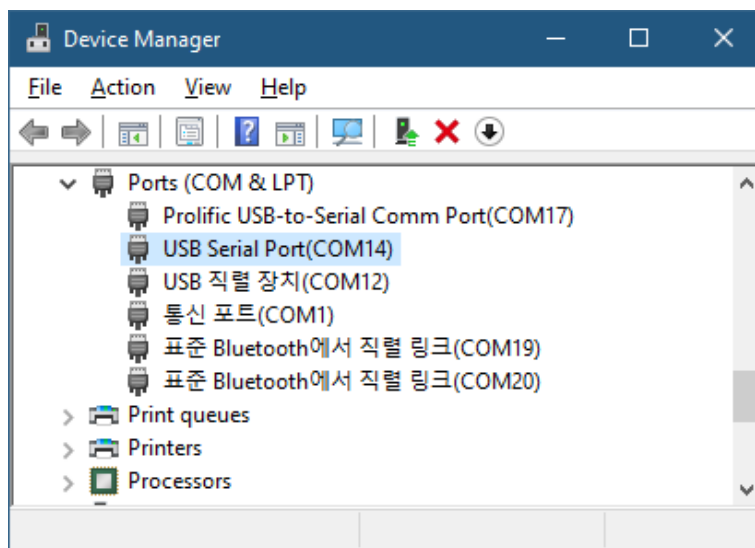

Fig B.4 Driver information of USB Serial Port (Windows 10)

B.4.1 How to change the address and type of IP with a user terminal program

Please refer to Fig B.5 and Fig B.6 as an example to change address and type of IP of RWC5021P. The internal baud rate of RWC5021P is fixed as 115200.

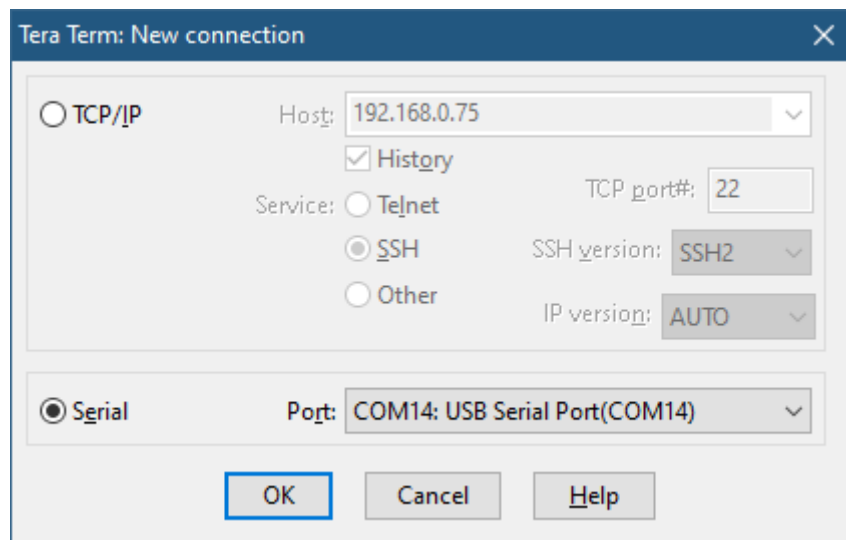

Fig B.5 Connection to the RWC5021P using Teraterm application

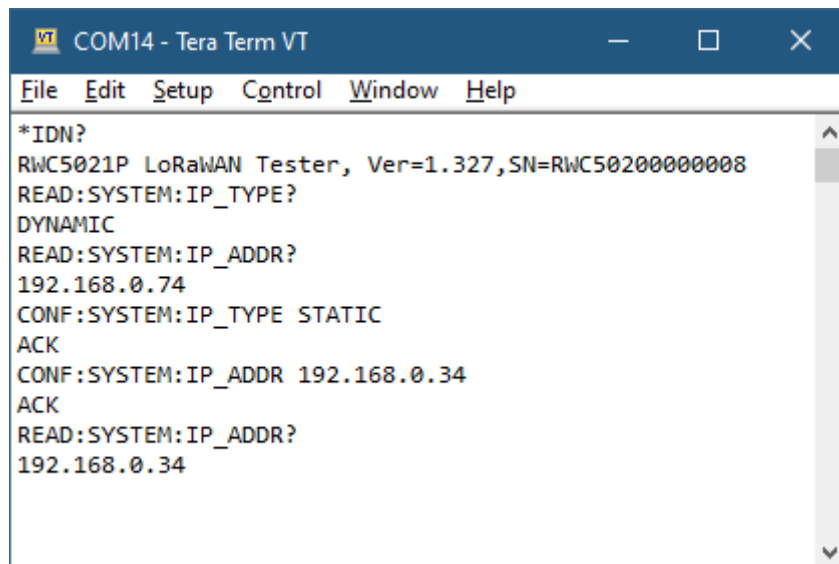

Fig B.6 Changing the address and type of IP using Teraterm application

B.4.2 How to change the address and type of IP with the RWC5020x/5021x application program

Making a connection between the application and RWC5021P

Step1) Open the RWC502x CONTROL PORT window

Step2) Scan COM ports by clicking [SCAN COM] button and select the specified COM port which is connected to the RWC5021P.

Step3) Make a connection by clicking the [CONNECT] button. The “Change Tester’s IP via COM

window” will be enabled.

Changing the address and type of IP

Step4) Get the current address and type of IP by clicking the [GET] button.

Step5) Change the current address and type of IP by clicking the [SET] button. Changing the IP address is available only in STATIC mode.

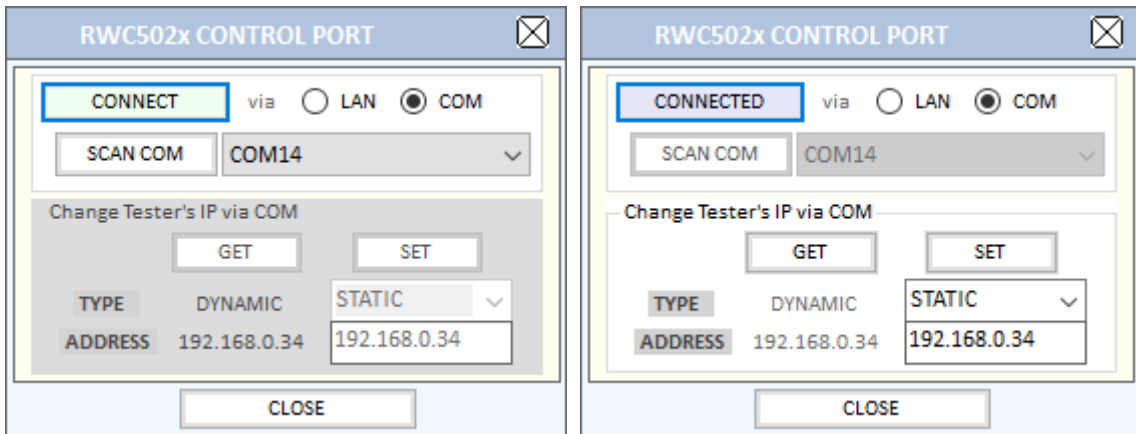

Fig B.7 Changing the address and type of IP using the RWC502x application

B.5 Firmware Upgrade

As RWC5021P adapted Flash Memory, it is available to upgrade easily by using a remote PC without changing the hardware. For upgrading, 'RWC_Updater' program shall be used, which is provided together when the product is purchased or available to download the upgrade package including itself and the upgrade binary files from RedwoodComm Website (<http://www.redwoodcomm.com>). The information for upgrading shall be kept in providing to the user via email or website.

Normal Firmware Upgrade Procedure via VCOM

- 1) Set up the UART connection between RWC5021P and a remote PC, using a USB C type cable
- 2) Turn RWC5021P power ON, and check the COM port number on Device Manager as follows. In the case of Windows 10 OS, the USB Serial Port(COMx) driver will be installed automatically. If not, users have to install the driver.

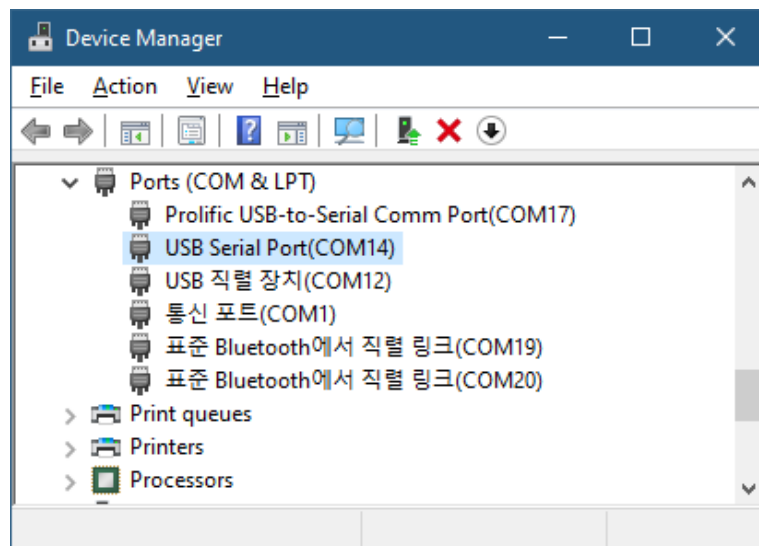

Fig B.8 Device Manager example screen

- 3) After downloading upgrade files from RedwoodComm website, execute an application program for upgrading.
- 4) Set up the COM port in the application program, and follow the instructions of the program.



Fig B.9 UART setting of Upgrader Program

- 5) During the upgrade, the RWC5021P indicates progress by flashing LEDs sequentially.
- 6) After upgrading completed, reboot RWC5021P and check the software version on the PC application program screen as follows.

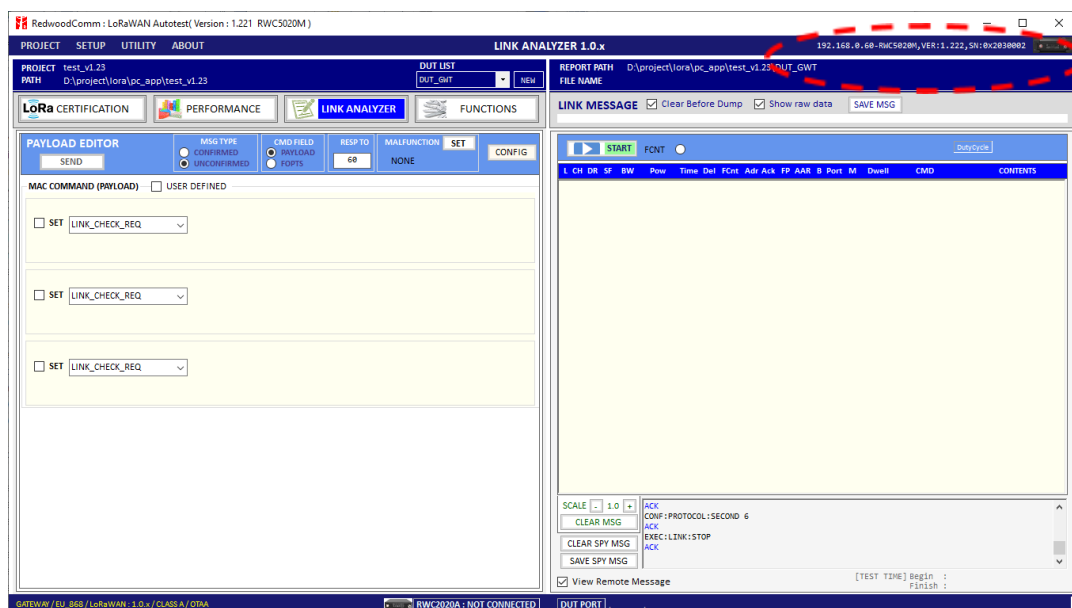

Fig B.10 PC Application Program

Normal Firmware Upgrade Procedure via Ethernet

- 1) Set up Ethernet connection between RWC5021P and a remote PC, using a RJ45 cable for normal

connection to network hub or using a crossover cable for direct connection between them.

- 2) In case of direct connection using a crossover cable, IP configuration of a remote PC should be done manually as the following figure. The IP address of a remote PC shall be set to the same as that of RWC5021P except the last number.

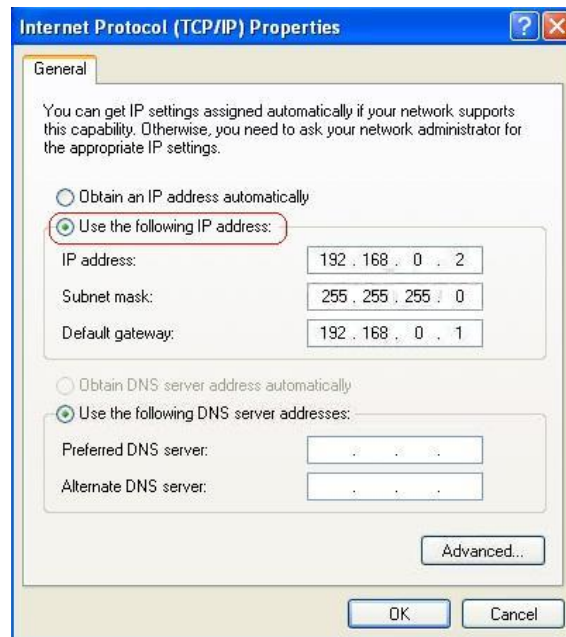

Fig B.11 IP configuration of a remote PC

CAUTION: For reliable upgrade, it is recommended to disable all other networks (e.g. WiFi, Virtual Machine) than Ethernet network in 'Change Adapter Settings' of a remote PC.

- 3) After downloading upgrade files from RedwoodComm website, execute an application program for upgrading.
- 4) Set up an IP address in the application program, and follow the instructions of the program.
- 5) During the upgrade, the RWC5021P indicates progress by flashing LEDs sequentially.
- 6) After upgrading completed, reboot RWC5021P and check the software version on the PC application program screen as follows.

CAUTION: If upgrading fails, turn on RWC5020M in Emergency Upgrade Mode and upgrade firmware again. Refer to “Emergency Firmware Upgrade Procedure”.

Emergency Firmware Upgrade Procedure

- 1) If Normal Firmware Upgrade Procedure fails during upgrading, the internal memory may be damaged. In this case, RWC5021P may not boot correctly. Then RWC5021P must be upgraded in Emergency Upgrade Mode.
- 2) Turn off RWC5021P. While keeping the FCN key pressed, turn on RWC5021P. Then RWC5021P will boot in Emergency Upgrade Mode.
- 3) Make a direct connection between a remote PC and RWC5021P using a crossover cable.
- 4) Follow the steps 3) to 6) of the Normal Firmware Upgrade Procedure.

B.6 Other Functions

See the Application Program Manual for details.